

ADDITIONAL NOTES:

Allotments used as Multiple Residential Allotments in accordance with the approved Plan of Development may have a reduced primary road setback to 3.0metres as noted on the Plan of Development Table.

Compaction of any fill material placed on this site shall be completed to level one inspection and testing services in accordance with AS3798-2007.



















Location of sewer, roofwater, stormwater, water reticulation and electricity lines, manholes and pits are those shown on engineering design drawings, supplied by Peak Urban and may differ from the as-constructed location.

Plan of Development information Supplied by RPS Group PLC.

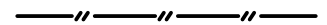
Copyright © Veris Australia Pty Ltd
December 2024

Plot Date: 11 Dec, 2024
 Computer File Ref: 30109-St4H-SP-(A).dwg

LEGEND

- Rock Retaining Wall shown as:- 
- Sleeper Retaining Wall shown as:- 
- Landscape Retaining Wall shown as:- 
- Sewer line 
- Sewer Manhole 
- Roofwater Drainage line and Catch Pit 
- Stormwater Drainage Line 
- Stormwater Manhole 
- Stormwater Pit 
- Water Main 
- Water Conduit 
- Water Service Point of Entry 
- Underground Electricity, Street Light, Electricity Pillar & NBN 
- Developer Fencing 
- Concrete Pathway 
- Landscape Street Tree 
- Zero Setback Building Line 
- Indicative Building Envelope 
- Bin Pads 
- Indicative Parking Access Location 

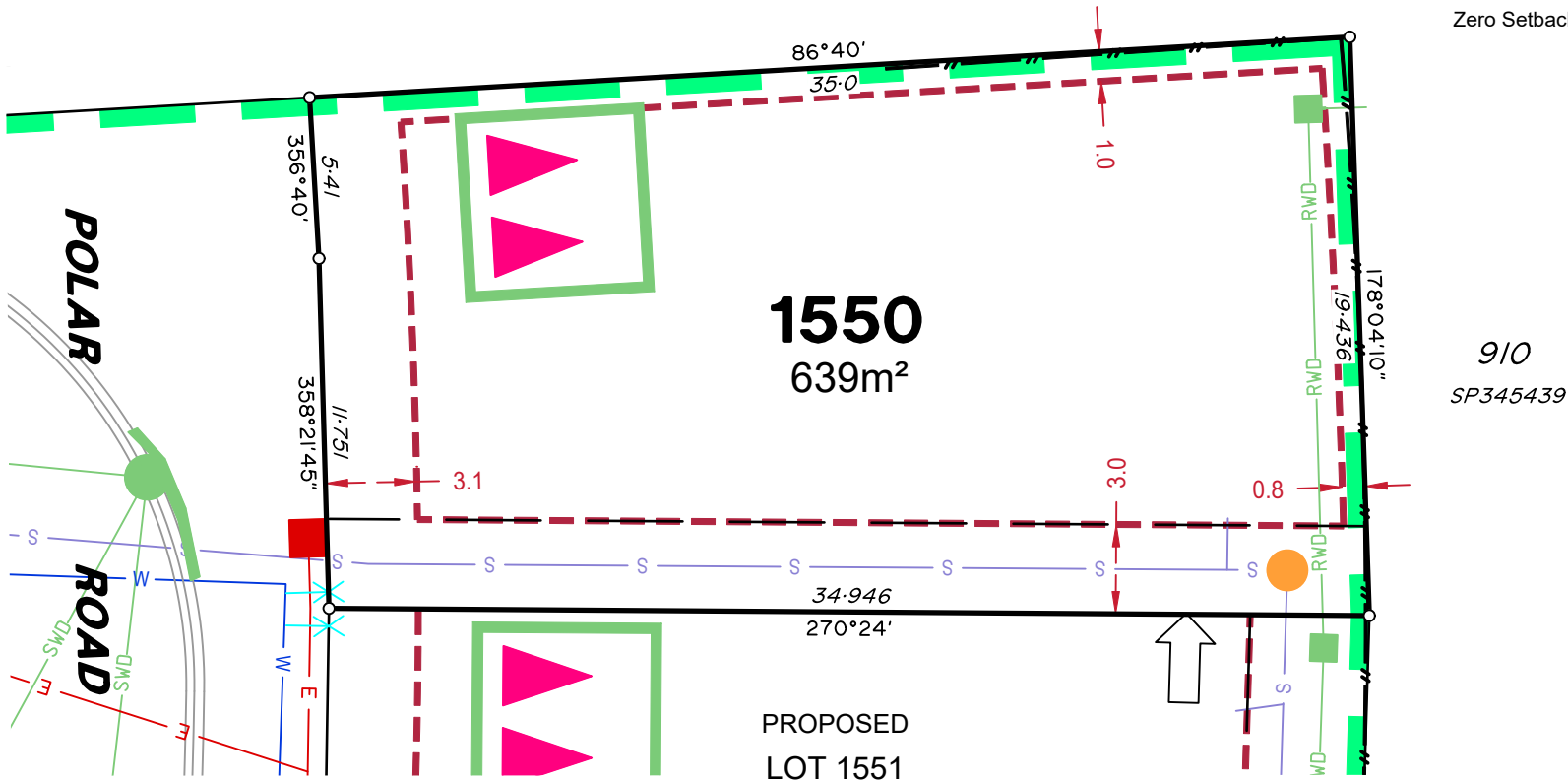

ADDITIONAL NOTES:

Allotments used as Multiple Residential Allotments in accordance with the approved Plan of Development may have a reduced primary road setback to 3.0metres as noted on the Plan of Development Table.

Compaction of any fill material placed on this site shall be completed to level one inspection and testing services in accordance with AS3798-2007.

Location of sewer, roofwater, stormwater, water reticulation and electricity lines, manholes and pits are those shown on engineering design drawings, supplied by Peak Urban and may differ from the as-constructed location.

Plan of Development information Supplied by RPS Group PLC.

Copyright © Veris Australia Pty Ltd
December 2024

Plot Date: 11 Dec, 2024
Computer File Ref: 30109-St4H-SP-(A).dwg

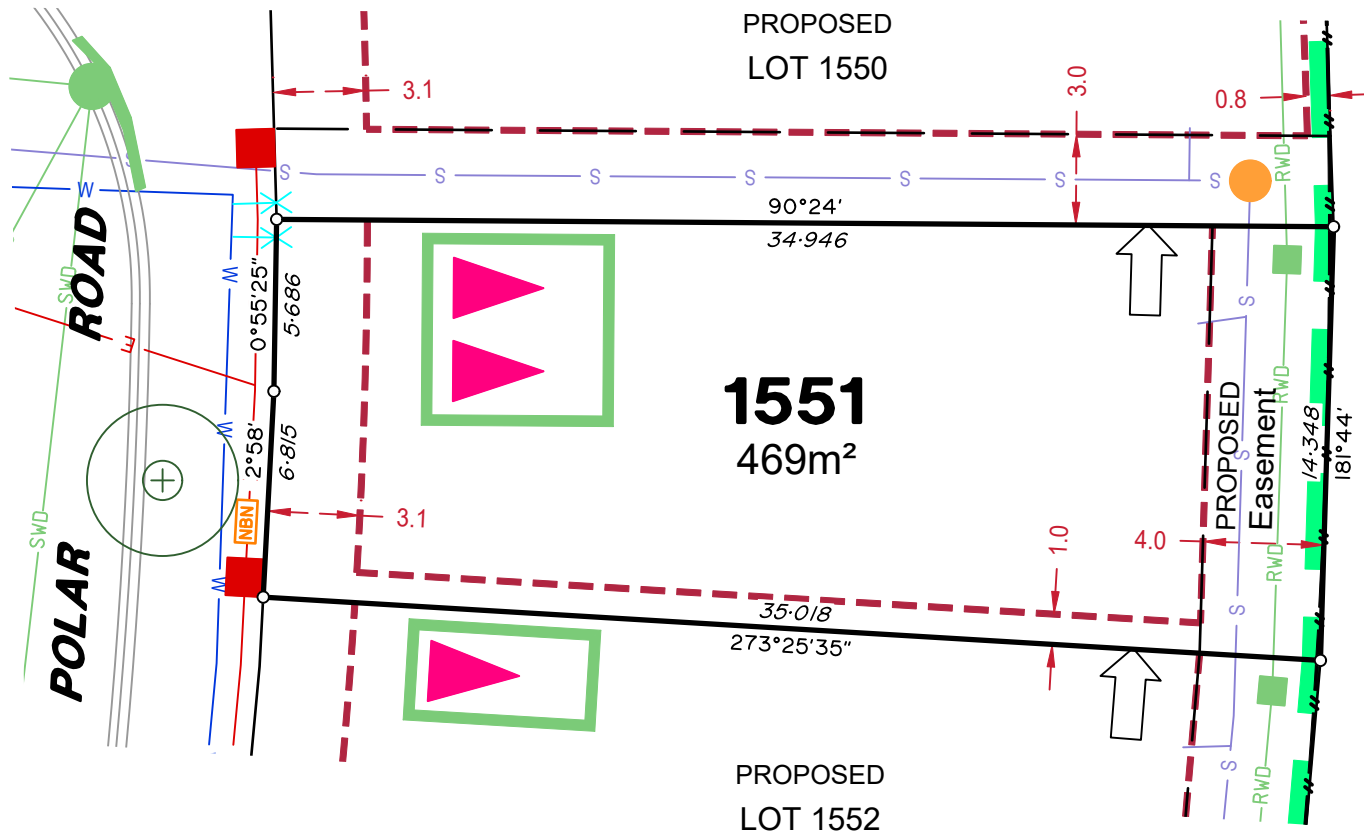

LEGEND

- Rock Retaining Wall shown as:-
- Sleeper Retaining Wall shown as:-
- Landscape Retaining Wall shown as:-
- Sewer line
- Sewer Manhole
- Roofwater Drainage line and Catch Pit
- Stormwater Drainage Line
- Stormwater Manhole
- Stormwater Pit
- Water Main
- Water Conduit
- Water Service Point of Entry
- Underground Electricity, Street Light, Electricity Pillar & NBN
- Developer Fencing
- Concrete Pathway
- Landscape Street Tree
- Zero Setback Building Line
- Indicative Building Envelope
- Bin Pads
- Indicative Parking Access Location

910
SP345439



ADDITIONAL NOTES:

Allotments used as Multiple Residential Allotments in accordance with the approved Plan of Development may have a reduced primary road setback to 3.0metres as noted on the Plan of Development Table.

Compaction of any fill material placed on this site shall be completed to level one inspection and testing services in accordance with AS3798-2007.

Location of sewer, roofwater, stormwater, water reticulation and electricity lines, manholes and pits are those shown on engineering design drawings, supplied by Peak Urban and may differ from the as-constructed location.

Plan of Development information Supplied by RPS Group PLC.

Copyright © Veris Australia Pty Ltd
December 2024

Plot Date: 11 Dec, 2024
 Computer File Ref: 30109-St4H-SP-(A).dwg

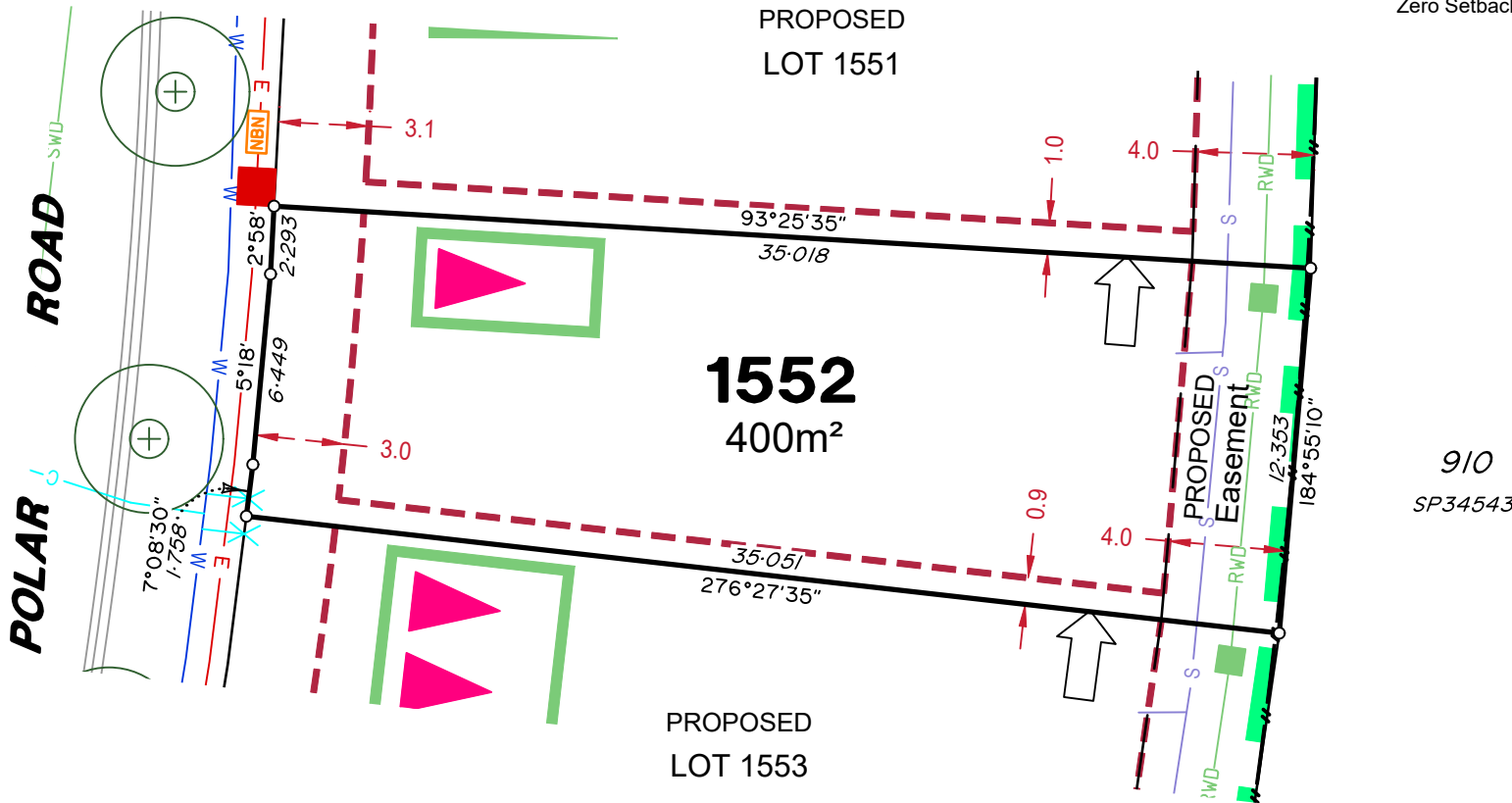

LEGEND

- Rock Retaining Wall shown as:-
- Sleeper Retaining Wall shown as:-
- Landscape Retaining Wall shown as:-
- Sewer line
- Sewer Manhole
- Roofwater Drainage line and Catch Pit
- Stormwater Drainage Line
- Stormwater Manhole
- Stormwater Pit
- Water Main
- Water Conduit
- Water Service Point of Entry
- Underground Electricity, Street Light, Electricity Pillar & NBN
- Developer Fencing
- Concrete Pathway
- Landscape Street Tree
- Zero Setback Building Line
- Indicative Building Envelope
- Bin Pads
- Indicative Parking Access Location



ADDITIONAL NOTES:

Allotments used as Multiple Residential Allotments in accordance with the approved Plan of Development may have a reduced primary road setback to 3.0metres as noted on the Plan of Development Table.

Compaction of any fill material placed on this site shall be completed to level one inspection and testing services in accordance with AS3798-2007.





















Location of sewer, roofwater, stormwater, water reticulation and electricity lines, manholes and pits are those shown on engineering design drawings, supplied by Peak Urban and may differ from the as-constructed location.

Plan of Development information Supplied by RPS Group PLC.

Copyright © Veris Australia Pty Ltd
December 2024

Plot Date: 11 Dec, 2024
 Computer File Ref: 30109-St4H-SP-(A).dwg

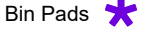
LEGEND

- Rock Retaining Wall shown as:- 
- Sleeper Retaining Wall shown as:- 
- Landscape Retaining Wall shown as:- 
- Sewer line 
- Sewer Manhole 
- Roofwater Drainage line and Catch Pit 
- Stormwater Drainage Line 
- Stormwater Manhole 
- Stormwater Pit 
- Water Main 
- Water Conduit 
- Water Service Point of Entry 
- Underground Electricity, Street Light, Electricity Pillar & NBN 
- Developer Fencing 
- Concrete Pathway 
- Landscape Street Tree 
- Zero Setback Building Line 
- Indicative Building Envelope 
- Bin Pads 
- Indicative Parking Access Location 

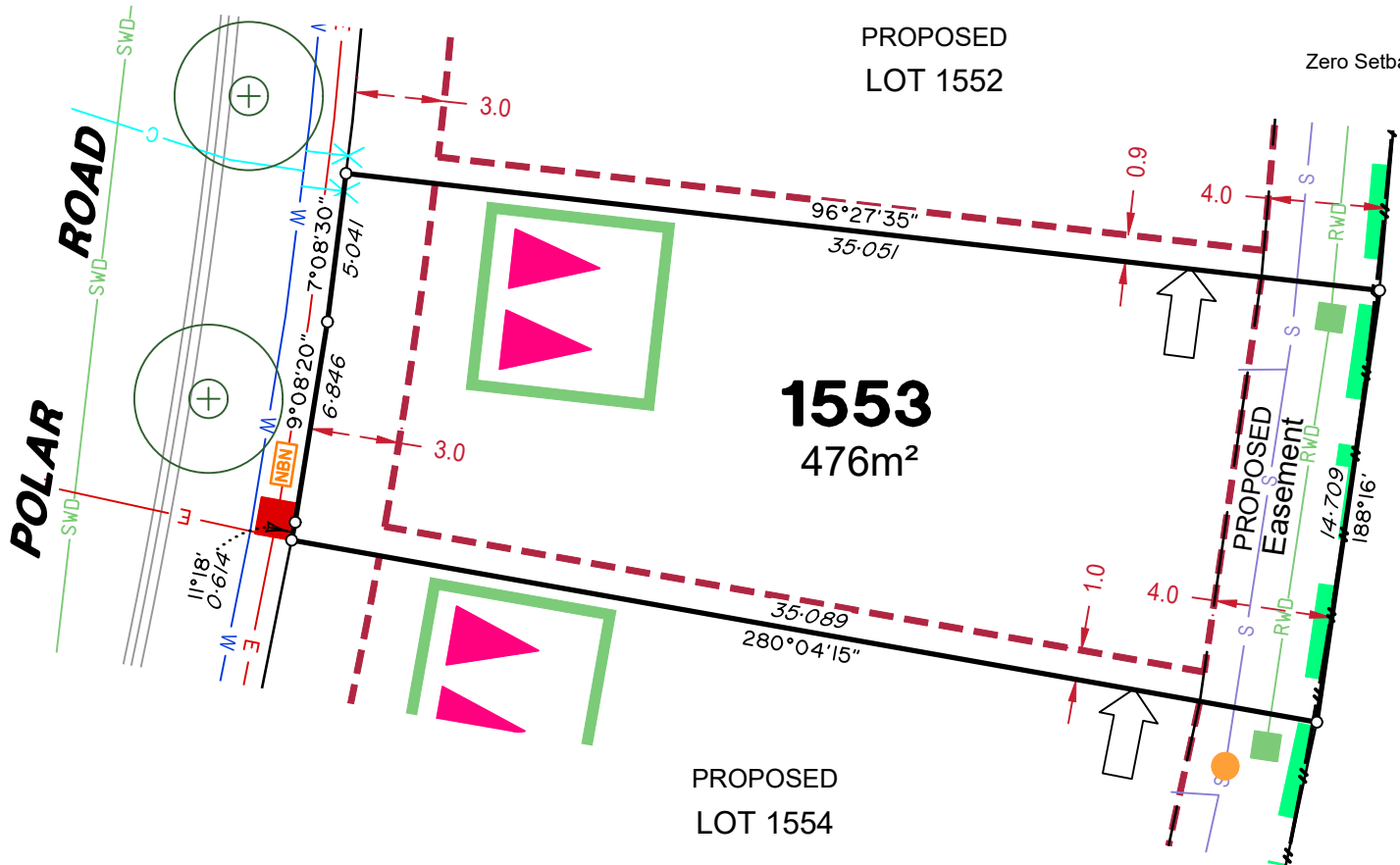

910
 SP345439



ADDITIONAL NOTES:

Allotments used as Multiple Residential Allotments in accordance with the approved Plan of Development may have a reduced primary road setback to 3.0metres as noted on the Plan of Development Table.

Compaction of any fill material placed on this site shall be completed to level one inspection and testing services in accordance with AS3798-2007.























Location of sewer, roofwater, stormwater, water reticulation and electricity lines, manholes and pits are those shown on engineering design drawings, supplied by Peak Urban and may differ from the as-constructed location.

Plan of Development information Supplied by RPS Group PLC.

Copyright © Veris Australia Pty Ltd
December 2024

Plot Date: 11 Dec, 2024
 Computer File Ref: 30109-St4H-SP-(A).dwg

LEGEND

- Rock Retaining Wall shown as:-  
- Sleeper Retaining Wall shown as:-  
- Landscape Retaining Wall shown as:-  
- Sewer line 
- Sewer Manhole 
- Roofwater Drainage line and Catch Pit 
- Stormwater Drainage Line 
- Stormwater Manhole 
- Stormwater Pit 
- Water Main 
- Water Conduit 
- Water Service Point of Entry 
- Underground Electricity, Street Light, Electricity Pillar & NBN 
- Developer Fencing 
- Concrete Pathway 
- Landscape Street Tree 
- Zero Setback Building Line 
- Indicative Building Envelope 
- Bin Pads 
- Indicative Parking Access Location 

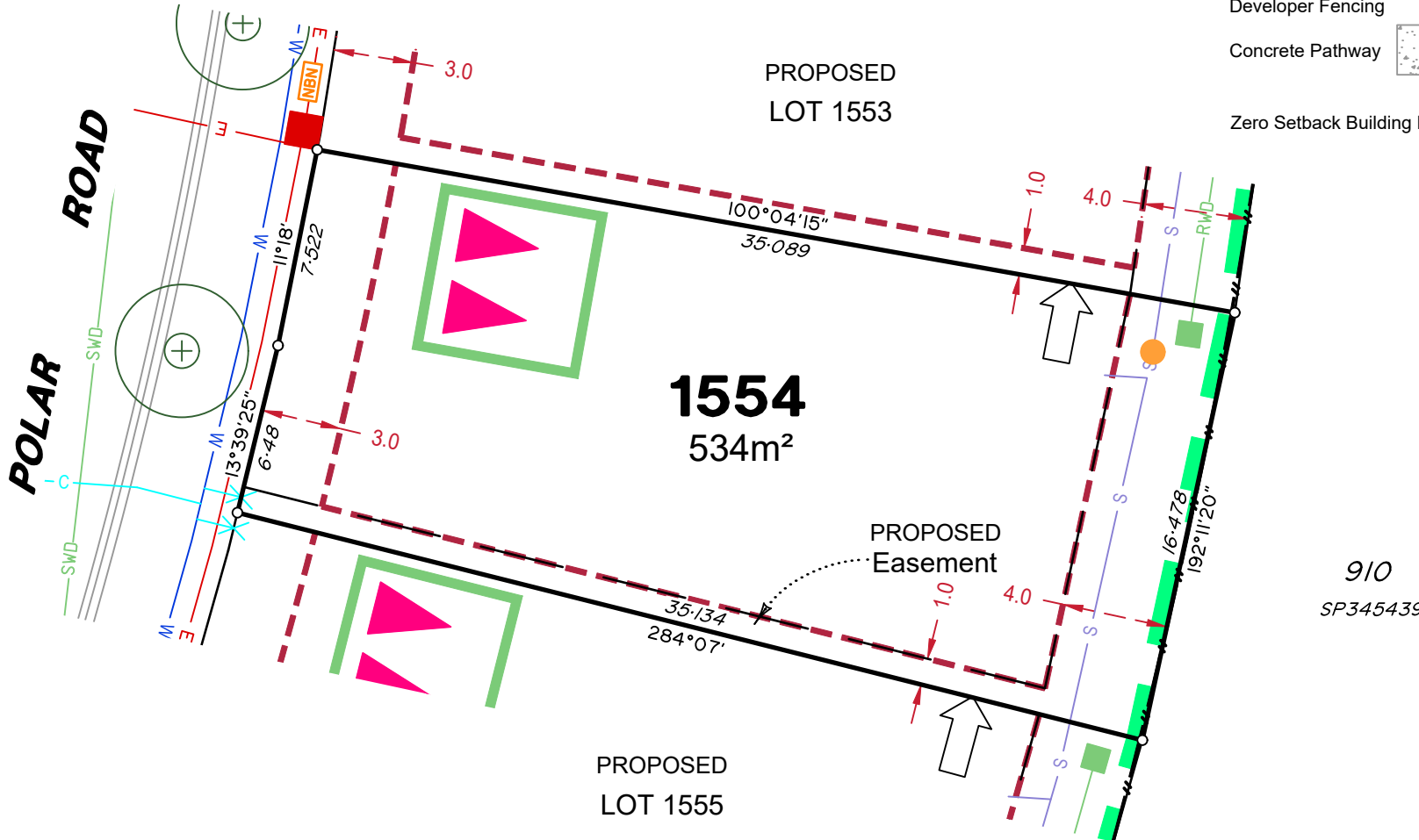

ADDITIONAL NOTES:

Allotments used as Multiple Residential Allotments in accordance with the approved Plan of Development may have a reduced primary road setback to 3.0metres as noted on the Plan of Development Table.

Compaction of any fill material placed on this site shall be completed to level one inspection and testing services in accordance with AS3798-2007.























Location of sewer, roofwater, stormwater, water reticulation and electricity lines, manholes and pits are those shown on engineering design drawings, supplied by Peak Urban and may differ from the as-constructed location.

Plan of Development information Supplied by RPS Group PLC.

Copyright © Veris Australia Pty Ltd
December 2024

Plot Date: 11 Dec, 2024
 Computer File Ref: 30109-St4H-SP-(A).dwg

LEGEND

- Rock Retaining Wall shown as:-  
- Sleeper Retaining Wall shown as:-  
- Landscape Retaining Wall shown as:-  
- Sewer line 
- Sewer Manhole 
- Roofwater Drainage line and Catch Pit 
- Stormwater Drainage Line 
- Stormwater Manhole 
- Stormwater Pit 
- Water Main 
- Water Conduit 
- Water Service Point of Entry 
- Underground Electricity, Street Light, Electricity Pillar & NBN 
- Developer Fencing 
- Concrete Pathway 
- Zero Setback Building Line 
- Landscape Street Tree 
- Indicative Building Envelope 
- Bin Pads 
- Indicative Parking Access Location 

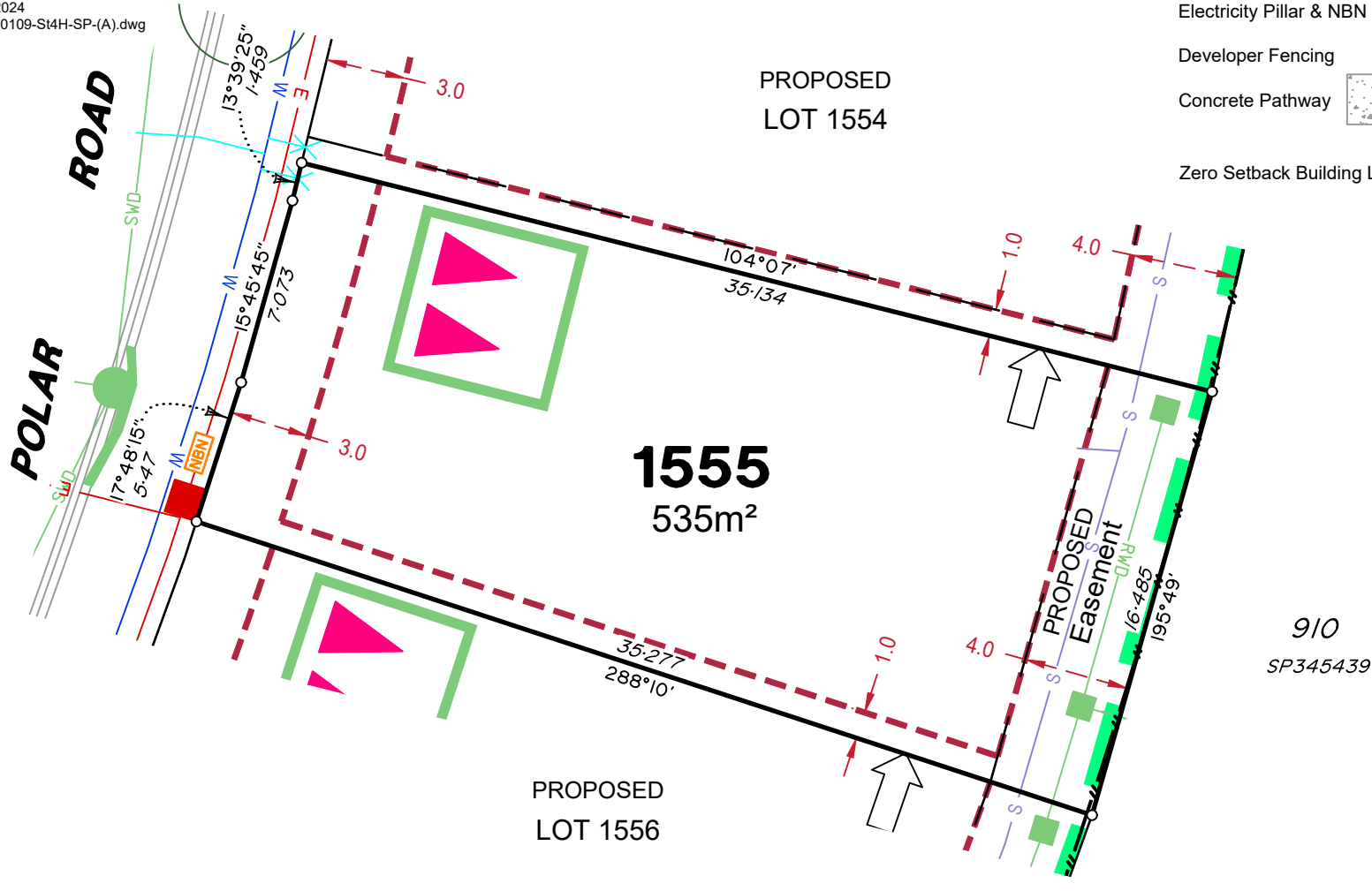

ADDITIONAL NOTES:

Allotments used as Multiple Residential Allotments in accordance with the approved Plan of Development may have a reduced primary road setback to 3.0metres as noted on the Plan of Development Table.

Compaction of any fill material placed on this site shall be completed to level one inspection and testing services in accordance with AS3798-2007.

Location of sewer, roofwater, stormwater, water reticulation and electricity lines, manholes and pits are those shown on engineering design drawings, supplied by Peak Urban and may differ from the as-constructed location.

Plan of Development information Supplied by RPS Group PLC.

Copyright © Veris Australia Pty Ltd
December 2024

Plot Date: 11 Dec, 2024
Computer File Ref: 30109-St4H-SP-(A).dwg

LEGEND

Rock Retaining Wall shown as:-	
Sleeper Retaining Wall shown as:-	
Landscape Retaining Wall shown as:-	
Sewer line	
Sewer Manhole	
Roofwater Drainage line and Catch Pit	
Stormwater Drainage Line	
Stormwater Manhole	
Stormwater Pit	
Water Main	
Water Conduit	
Water Service Point of Entry	
Underground Electricity, Street Light, Electricity Pillar & NBN	
Developer Fencing	
Concrete Pathway	
Zero Setback Building Line	
Landscape Street Tree	
Indicative Building Envelope	
Bin Pads	
Indicative Parking Access Location	

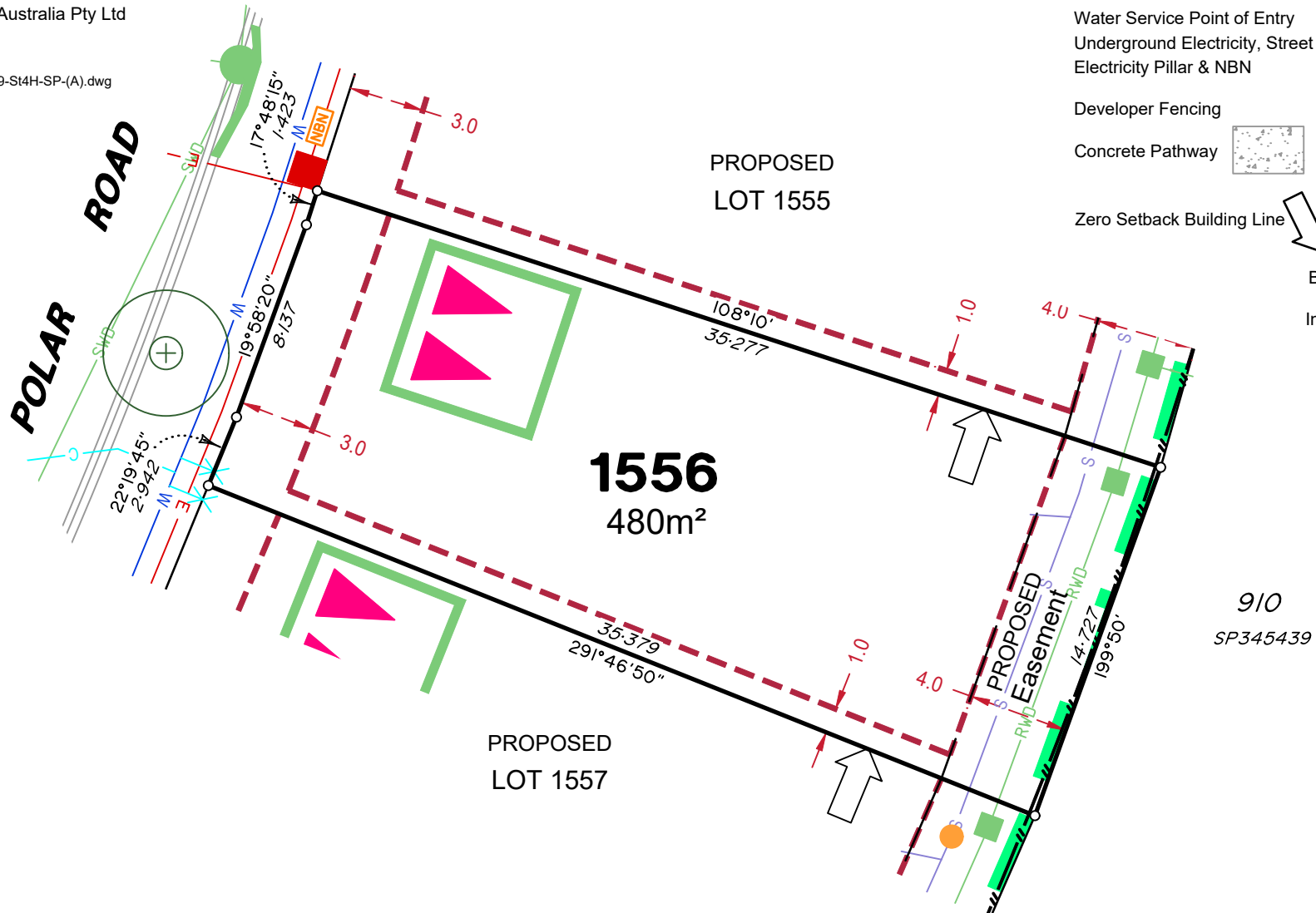

910
SP345439

ADDITIONAL NOTES:

Allotments used as Multiple Residential Allotments in accordance with the approved Plan of Development may have a reduced primary road setback to 3.0metres as noted on the Plan of Development Table.

Compaction of any fill material placed on this site shall be completed to level one inspection and testing services in accordance with AS3798-2007.





















Location of sewer, roofwater, stormwater, water reticulation and electricity lines, manholes and pits are those shown on engineering design drawings, supplied by Peak Urban and may differ from the as-constructed location.

Plan of Development information Supplied by RPS Group PLC.

Copyright © Veris Australia Pty Ltd
December 2024

Plot Date: 11 Dec, 2024
Computer File Ref: 30109-S4H-SP-(A).dwg

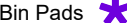
LEGEND

- Rock Retaining Wall shown as:- 
- Sleeper Retaining Wall shown as:- 
- Landscape Retaining Wall shown as:- 
- Sewer line 
- Sewer Manhole 
- Roofwater Drainage line and Catch Pit 
- Stormwater Drainage Line 
- Stormwater Manhole 
- Stormwater Pit 
- Water Main 
- Water Conduit 
- Water Service Point of Entry 
- Underground Electricity, Street Light, Electricity Pillar & NBN 
- Developer Fencing 
- Concrete Pathway 
- Landscape Street Tree 
- Zero Setback Building Line 
- Indicative Building Envelope 
- Bin Pads 
- Indicative Parking Access Location 

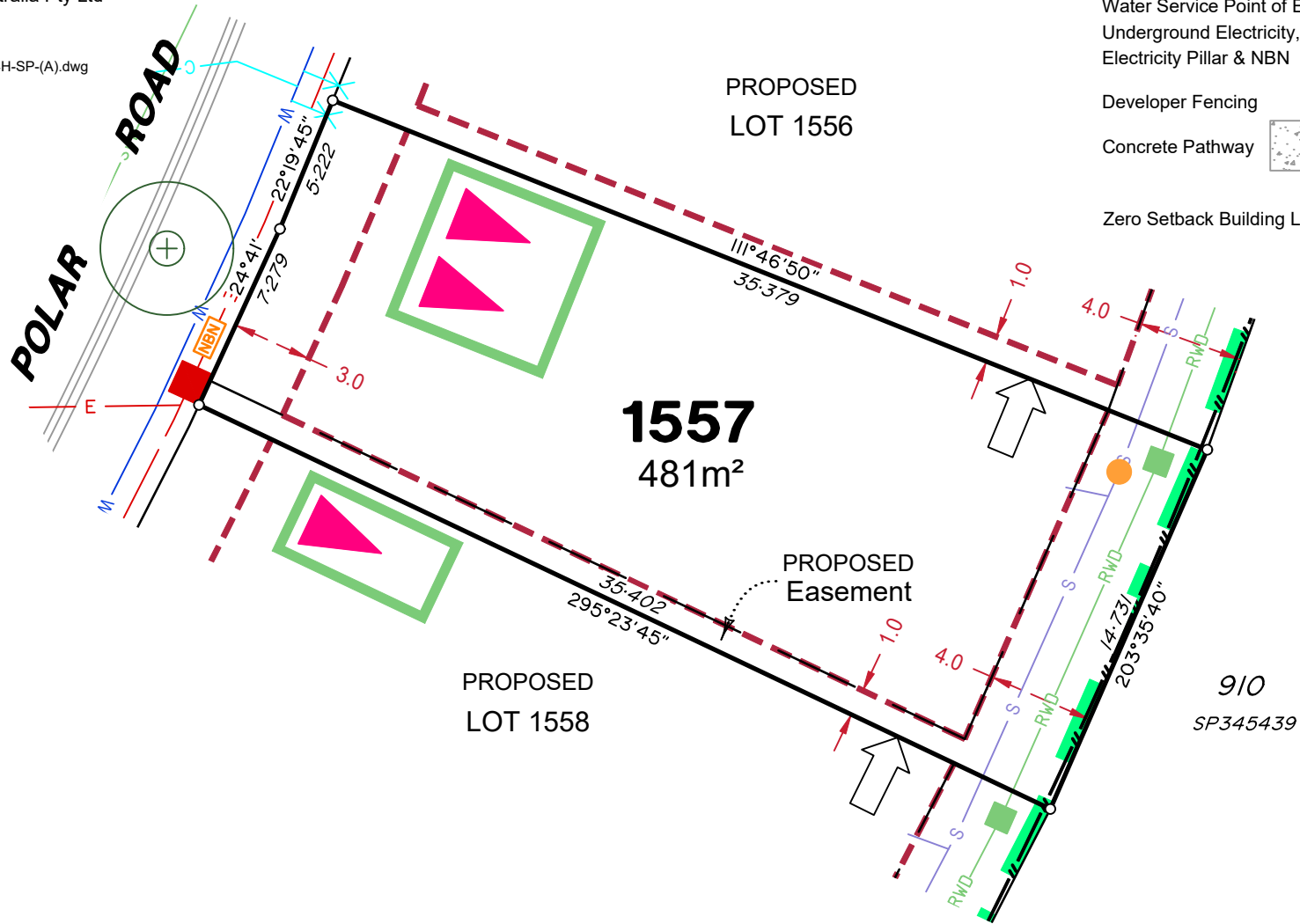

ADDITIONAL NOTES:

Allotments used as Multiple Residential Allotments in accordance with the approved Plan of Development may have a reduced primary road setback to 3.0metres as noted on the Plan of Development Table.

Compaction of any fill material placed on this site shall be completed to level one inspection and testing services in accordance with AS3798-2007.























Location of sewer, roofwater, stormwater, water reticulation and electricity lines, manholes and pits are those shown on engineering design drawings, supplied by Peak Urban and may differ from the as-constructed location.

Plan of Development information Supplied by RPS Group PLC.

Copyright © Veris Australia Pty Ltd
December 2024

Plot Date: 11 Dec, 2024
Computer File Ref: 30109-St4H-SP-(A).dwg

LEGEND

- Rock Retaining Wall shown as:-  
- Sleeper Retaining Wall shown as:-  
- Landscape Retaining Wall shown as:-  
- Sewer line 
- Sewer Manhole 
- Roofwater Drainage line and Catch Pit 
- Stormwater Drainage Line 
- Stormwater Manhole 
- Stormwater Pit 
- Water Main 
- Water Conduit 
- Water Service Point of Entry 
- Underground Electricity, Street Light, Electricity Pillar & NBN 
- Developer Fencing 
- Concrete Pathway 
- Landscape Street Tree 
- Zero Setback Building Line 
- Indicative Building Envelope 
- Bin Pads 
- Indicative Parking Access Location 

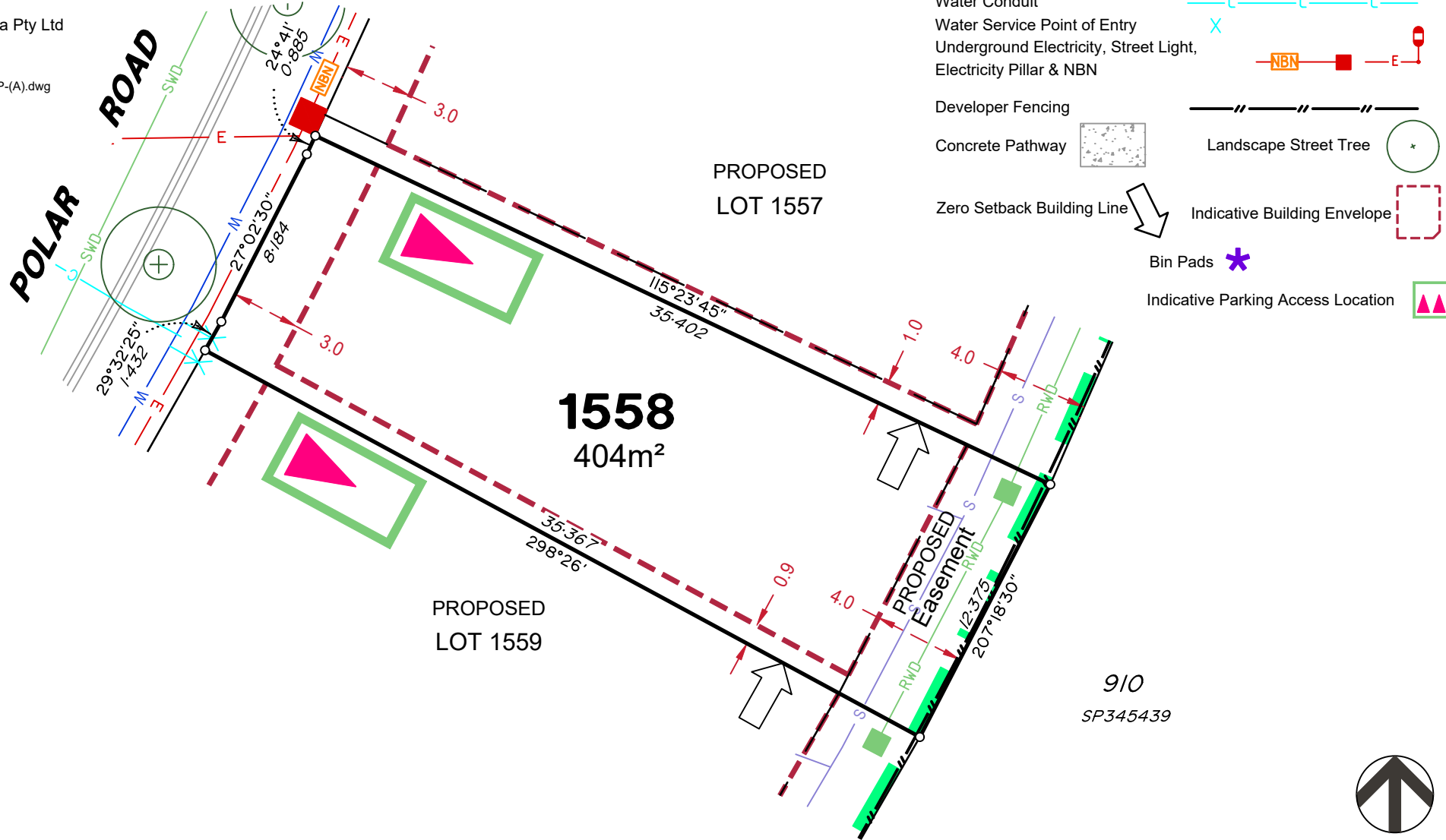

910
SP345439



ADDITIONAL NOTES:

Allotments used as Multiple Residential Allotments in accordance with the approved Plan of Development may have a reduced primary road setback to 3.0metres as noted on the Plan of Development Table.

Compaction of any fill material placed on this site shall be completed to level one inspection and testing services in accordance with AS3798-2007.

Location of sewer, roofwater, stormwater, water reticulation and electricity lines, manholes and pits are those shown on engineering design drawings, supplied by Peak Urban and may differ from the as-constructed location.

Plan of Development information Supplied by RPS Group PLC.

Copyright © Veris Australia Pty Ltd
December 2024

Plot Date: 11 Dec, 2024
Computer File Ref: 30109-St4H-SP-(A).dwg

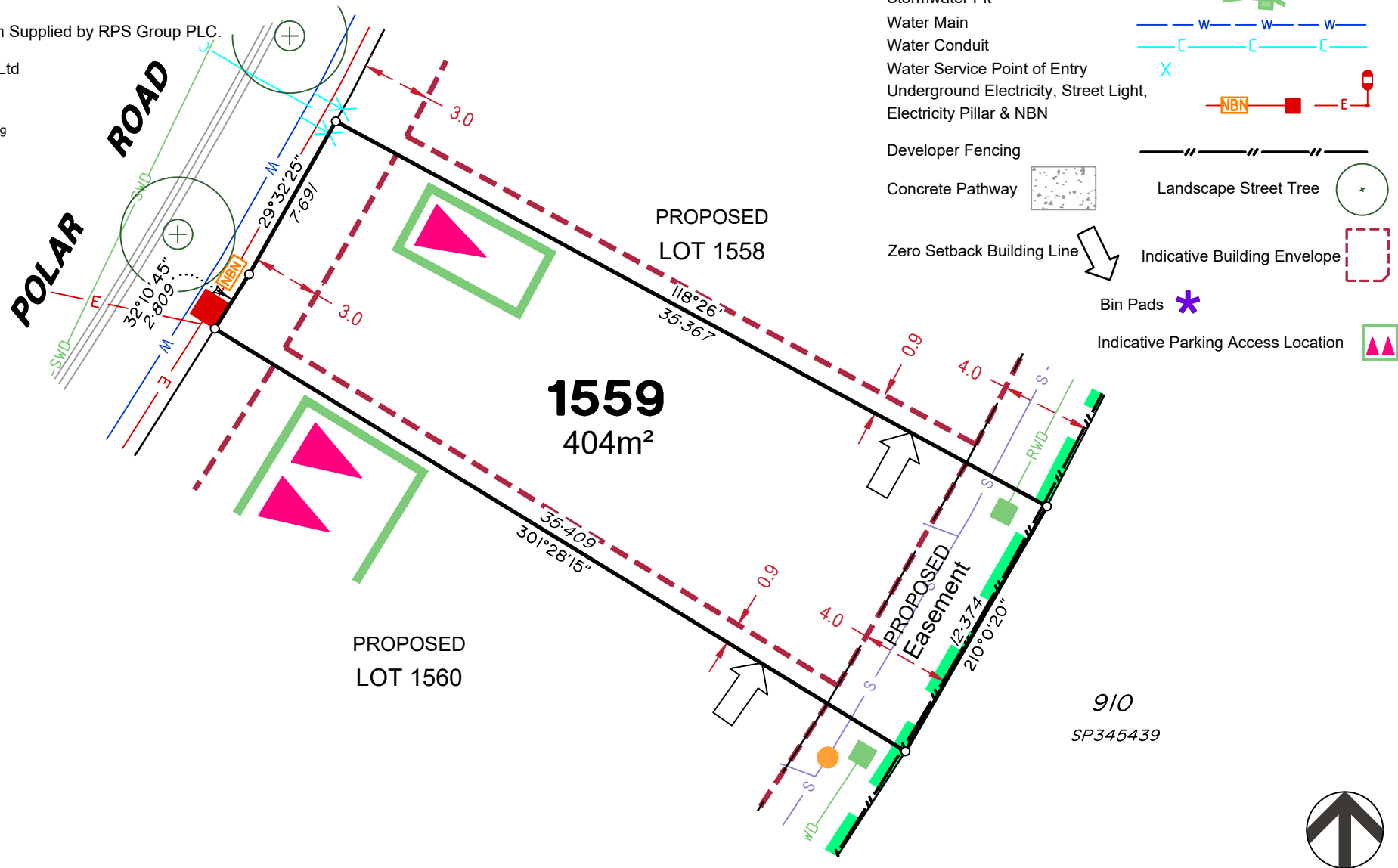

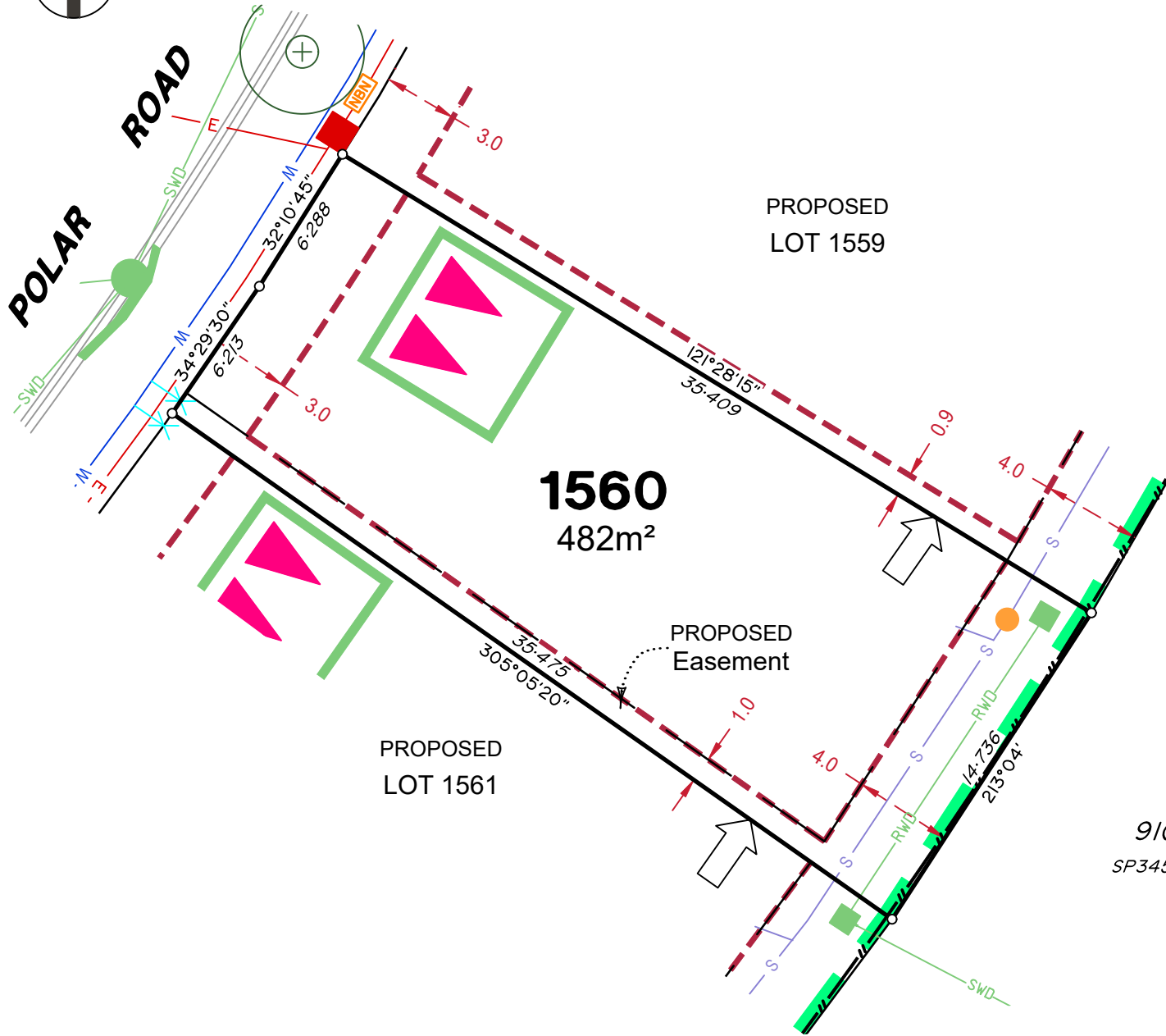

LEGEND

Rock Retaining Wall shown as:-	
Sleeper Retaining Wall shown as:-	
Landscape Retaining Wall shown as:-	
Sewer line	
Sewer Manhole	
Roofwater Drainage line and Catch Pit	
Stormwater Drainage Line	
Stormwater Manhole	
Stormwater Pit	
Water Main	
Water Conduit	
Water Service Point of Entry	
Underground Electricity, Street Light, Electricity Pillar & NBN	
Developer Fencing	
Concrete Pathway	
Landscaped Street Tree	
Zero Setback Building Line	
Indicative Building Envelope	
Bin Pads	
Indicative Parking Access Location	

ADDITIONAL NOTES:

Allotments used as Multiple Residential Allotments in accordance with the approved Plan of Development may have a reduced primary road setback to 3.0metres as noted on the Plan of Development Table.

Compaction of any fill material placed on this site shall be completed to level one inspection and testing services in accordance with AS3798-2007.

Location of sewer, roofwater, stormwater, water reticulation and electricity lines, manholes and pits are those shown on engineering design drawings, supplied by Peak Urban and may differ from the as-constructed location.

Plan of Development information Supplied by RPS Group PLC.

Copyright © Veris Australia Pty Ltd
December 2024

Plot Date: 11 Dec, 2024
Computer File Ref: 30109-St4H-SP-(A).dwg

910
SP345439

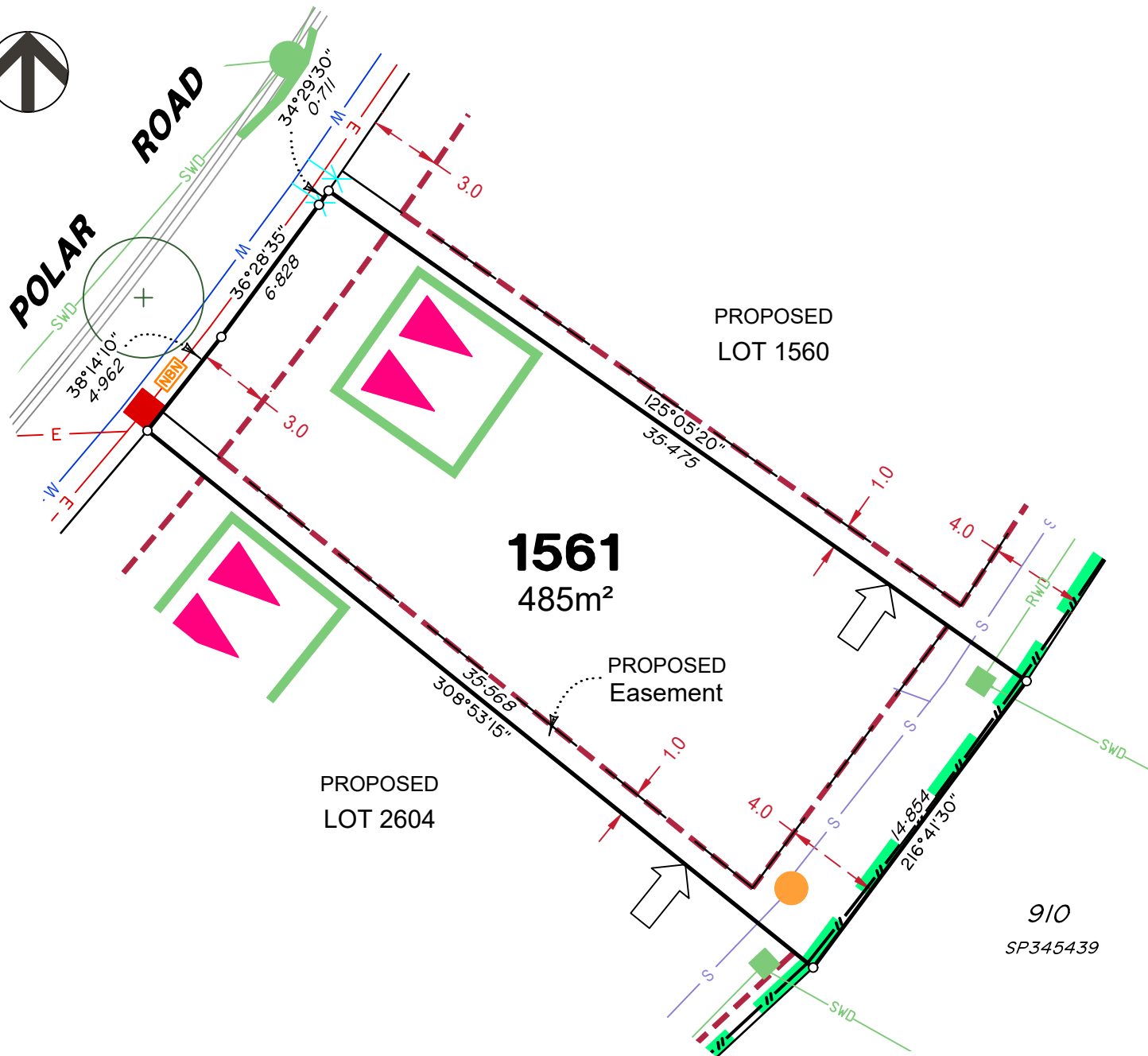

LEGEND

Rock Retaining Wall shown as:-		
Sleeper Retaining Wall shown as:-		
Landscape Retaining Wall shown as:-		
Sewer line		
Sewer Manhole		
Roofwater Drainage line and Catch Pit		
Stormwater Drainage Line		
Stormwater Manhole		
Stormwater Pit		
Water Main		
Water Conduit		
Water Service Point of Entry		
Underground Electricity, Street Light, Electricity Pillar & NBN		
Developer Fencing		
Concrete Pathway		
Zero Setback Building Line		
Indicative Building Envelope		
Bin Pads		
Indicative Parking Access Location		

ADDITIONAL NOTES:

Allotments used as Multiple Residential Allotments in accordance with the approved Plan of Development may have a reduced primary road setback to 3.0metres as noted on the Plan of Development Table.

Compaction of any fill material placed on this site shall be completed to level one inspection and testing services in accordance with AS3798-2007.

Location of sewer, roofwater, stormwater, water reticulation and electricity lines, manholes and pits are those shown on engineering design drawings, supplied by Peak Urban and may differ from the as-constructed location.

Plan of Development information Supplied by RPS Group PLC.

Copyright © Veris Australia Pty Ltd
December 2024

Plot Date: 11 Dec, 2024
Computer File Ref: 30109-St4H-SP-(A).dwg

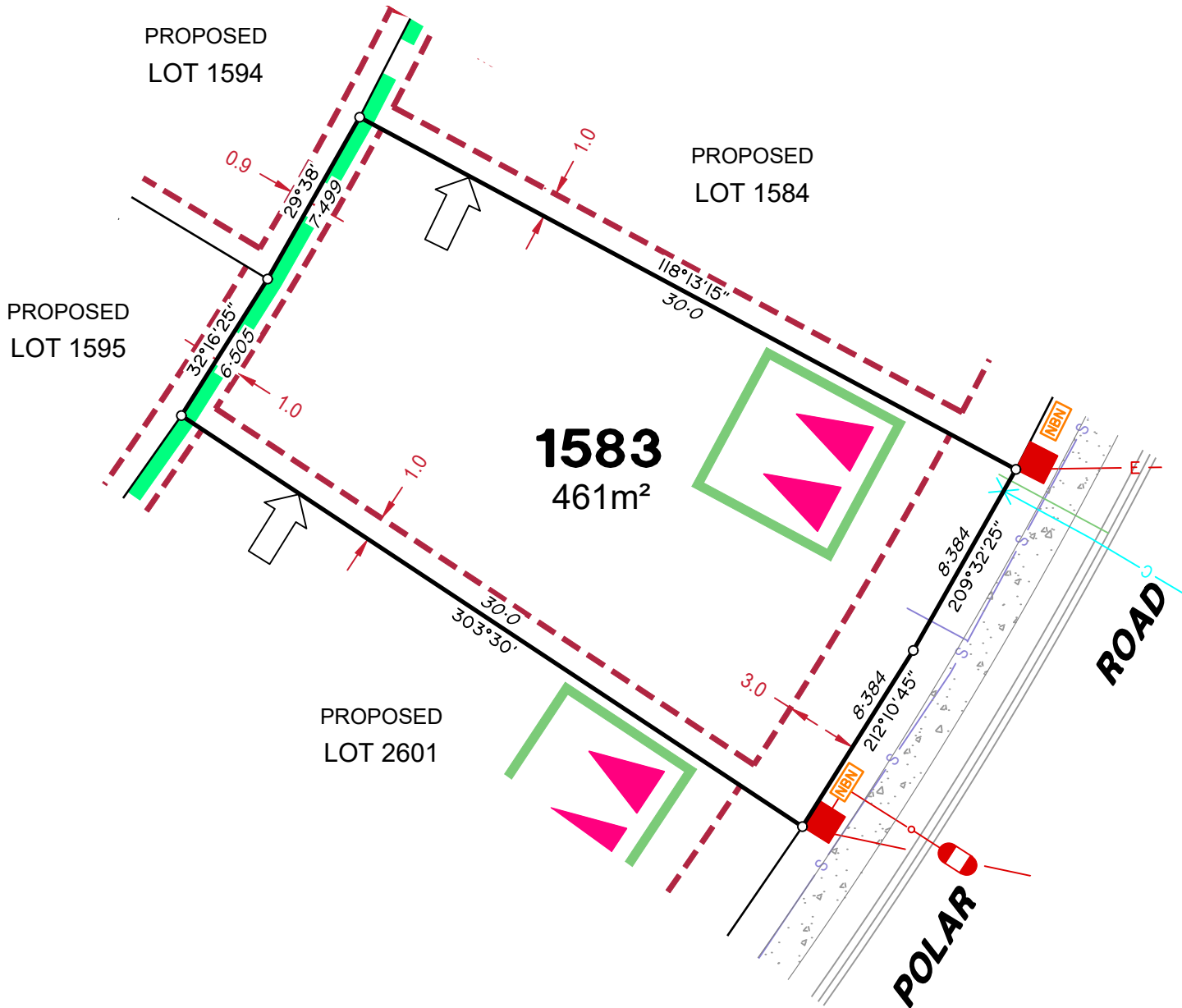

LEGEND

Rock Retaining Wall shown as:-	
Sleeper Retaining Wall shown as:-	
Landscape Retaining Wall shown as:-	
Sewer line	
Sewer Manhole	
Roofwater Drainage line and Catch Pit	
Stormwater Drainage Line	
Stormwater Manhole	
Stormwater Pit	
Water Main	
Water Conduit	
Water Service Point of Entry	
Underground Electricity, Street Light, Electricity Pillar & NBN	
Developer Fencing	
Concrete Pathway	
Zero Setback Building Line	
Landscape Street Tree	
Indicative Building Envelope	
Bin Pads	
Indicative Parking Access Location	

ADDITIONAL NOTES:

Allotments used as Multiple Residential Allotments in accordance with the approved Plan of Development may have a reduced primary road setback to 3.0metres as noted on the Plan of Development Table.

Compaction of any fill material placed on this site shall be completed to level one inspection and testing services in accordance with AS3798-2007.

Location of sewer, roofwater, stormwater, water reticulation and electricity lines, manholes and pits are those shown on engineering design drawings, supplied by Peak Urban and may differ from the as-constructed location.

Plan of Development information Supplied by RPS Group PLC.

Copyright © Veris Australia Pty Ltd
December 2024

Plot Date: 11 Dec, 2024
Computer File Ref: 30109-S4H-SP-(A).dwg

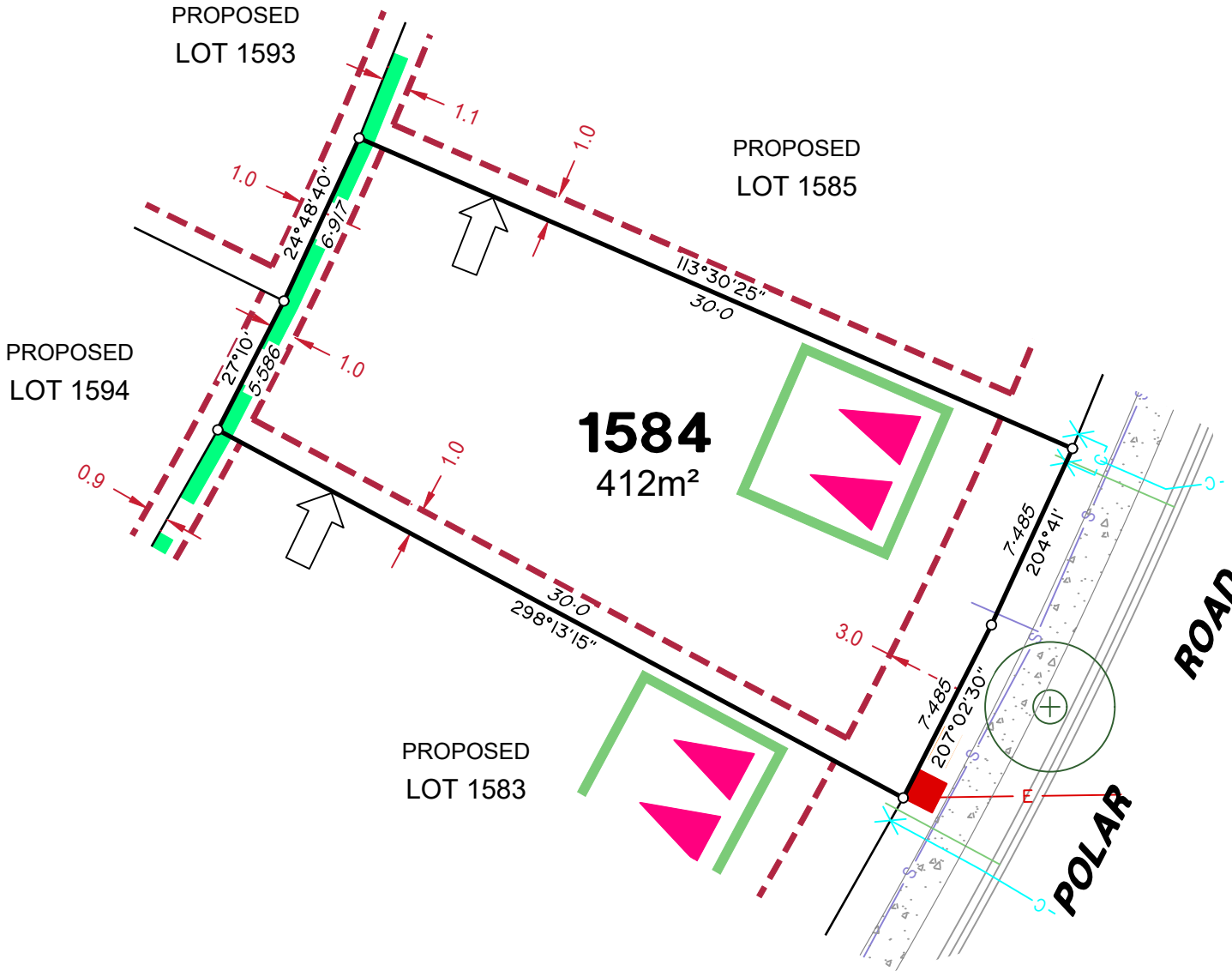

LEGEND

Rock Retaining Wall shown as:-	
Sleeper Retaining Wall shown as:-	
Landscape Retaining Wall shown as:-	
Sewer line	
Sewer Manhole	
Roofwater Drainage line and Catch Pit	
Stormwater Drainage Line	
Stormwater Manhole	
Stormwater Pit	
Water Main	
Water Conduit	
Water Service Point of Entry	
Underground Electricity, Street Light, Electricity Pillar & NBN	
Developer Fencing	
Concrete Pathway	
Landscape Street Tree	
Zero Setback Building Line	
Indicative Building Envelope	
Bin Pads	
Indicative Parking Access Location	

ADDITIONAL NOTES:

Allotments used as Multiple Residential Allotments in accordance with the approved Plan of Development may have a reduced primary road setback to 3.0metres as noted on the Plan of Development Table.

Compaction of any fill material placed on this site shall be completed to level one inspection and testing services in accordance with AS3798-2007.

Location of sewer, roofwater, stormwater, water reticulation and electricity lines, manholes and pits are those shown on engineering design drawings, supplied by Peak Urban and may differ from the as-constructed location.

Plan of Development information Supplied by RPS Group PLC.

Copyright © Veris Australia Pty Ltd
December 2024

Plot Date: 11 Dec, 2024
Computer File Ref: 30109-St4H-SP-(A).dwg

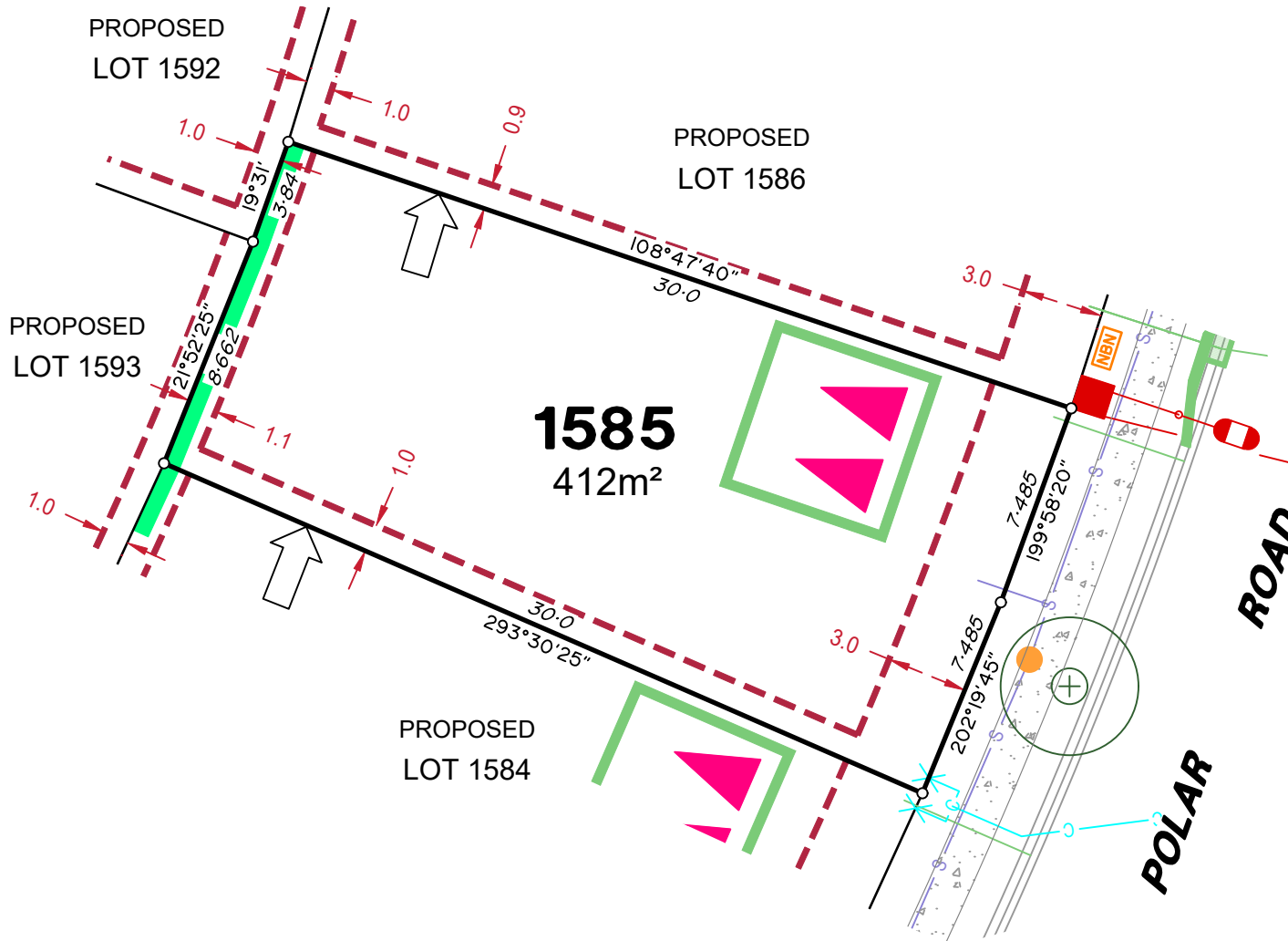

LEGEND

Rock Retaining Wall shown as:-	
Sleeper Retaining Wall shown as:-	
Landscape Retaining Wall shown as:-	
Sewer line	
Sewer Manhole	
Roofwater Drainage line and Catch Pit	
Stormwater Drainage Line	
Stormwater Manhole	
Stormwater Pit	
Water Main	
Water Conduit	
Water Service Point of Entry	
Underground Electricity, Street Light, Electricity Pillar & NBN	
Developer Fencing	
Concrete Pathway	
Zero Setback Building Line	
Landscape Street Tree	
Indicative Building Envelope	
Bin Pads	
Indicative Parking Access Location	

ADDITIONAL NOTES:

Allotments used as Multiple Residential Allotments in accordance with the approved Plan of Development may have a reduced primary road setback to 3.0metres as noted on the Plan of Development Table.

Compaction of any fill material placed on this site shall be completed to level one inspection and testing services in accordance with AS3798-2007.

Location of sewer, roofwater, stormwater, water reticulation and electricity lines, manholes and pits are those shown on engineering design drawings, supplied by Peak Urban and may differ from the as-constructed location.

Plan of Development information Supplied by RPS Group PLC.

Copyright © Veris Australia Pty Ltd
December 2024

Plot Date: 11 Dec, 2024
 Computer File Ref: 30109-St4H-SP-(A).dwg

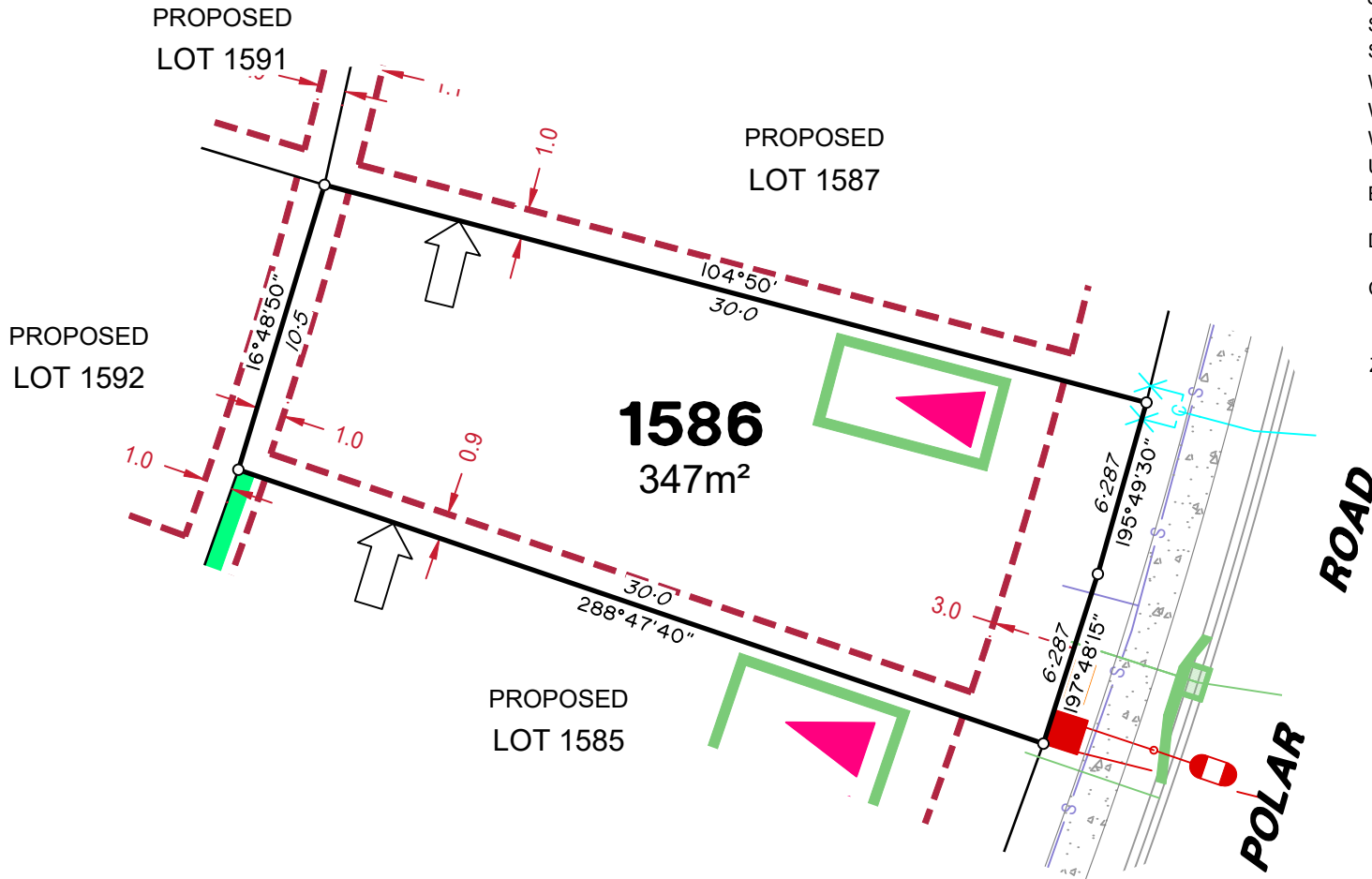

LEGEND

Rock Retaining Wall shown as:-	
Sleeper Retaining Wall shown as:-	
Landscape Retaining Wall shown as:-	
Sewer line	
Sewer Manhole	
Roofwater Drainage line and Catch Pit	
Stormwater Drainage Line	
Stormwater Manhole	
Stormwater Pit	
Water Main	
Water Conduit	
Water Service Point of Entry	
Underground Electricity, Street Light, Electricity Pillar & NBN	
Developer Fencing	
Concrete Pathway	
Zero Setback Building Line	
Landscape Street Tree	
Indicative Building Envelope	
Bin Pads	
Indicative Parking Access Location	

ADDITIONAL NOTES:

Allotments used as Multiple Residential Allotments in accordance with the approved Plan of Development may have a reduced primary road setback to 3.0metres as noted on the Plan of Development Table.

Compaction of any fill material placed on this site shall be completed to level one inspection and testing services in accordance with AS3798-2007.

Location of sewer, roofwater, stormwater, water reticulation and electricity lines, manholes and pits are those shown on engineering design drawings, supplied by Peak Urban and may differ from the as-constructed location.

Plan of Development information Supplied by RPS Group PLC.

Copyright © Veris Australia Pty Ltd
December 2024

Plot Date: 11 Dec, 2024
Computer File Ref: 30109-St4H-SP-(A).dwg

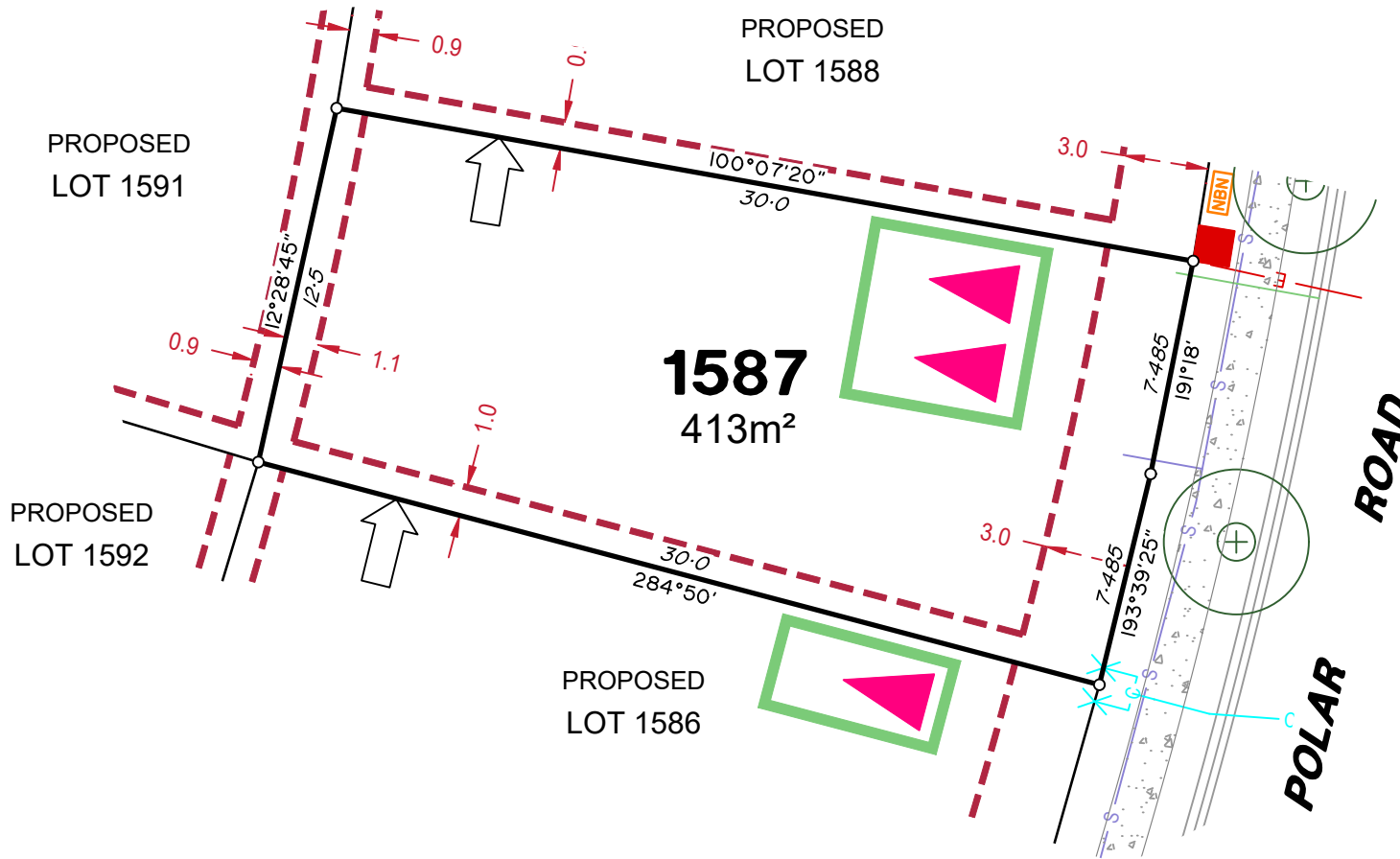

LEGEND

Rock Retaining Wall shown as:-	
Sleeper Retaining Wall shown as:-	
Landscape Retaining Wall shown as:-	
Sewer line	
Sewer Manhole	
Roofwater Drainage line and Catch Pit	
Stormwater Drainage Line	
Stormwater Manhole	
Stormwater Pit	
Water Main	
Water Conduit	
Water Service Point of Entry	
Underground Electricity, Street Light, Electricity Pillar & NBN	
Developer Fencing	
Concrete Pathway	
Zero Setback Building Line	
Landscape Street Tree	
Indicative Building Envelope	
Bin Pads	
Indicative Parking Access Location	

ADDITIONAL NOTES:

Allotments used as Multiple Residential Allotments in accordance with the approved Plan of Development may have a reduced primary road setback to 3.0metres as noted on the Plan of Development Table.

Compaction of any fill material placed on this site shall be completed to level one inspection and testing services in accordance with AS3798-2007.

Location of sewer, roofwater, stormwater, water reticulation and electricity lines, manholes and pits are those shown on engineering design drawings, supplied by Peak Urban and may differ from the as-constructed location.

Plan of Development information Supplied by RPS Group PLC.

Copyright © Veris Australia Pty Ltd
December 2024

Plot Date: 11 Dec, 2024
Computer File Ref: 30109-St4H-SP-(A).dwg



LEGEND

Rock Retaining Wall shown as:-	
Sleeper Retaining Wall shown as:-	
Landscape Retaining Wall shown as:-	
Sewer line	
Sewer Manhole	
Roofwater Drainage line and Catch Pit	
Stormwater Drainage Line	
Stormwater Manhole	
Stormwater Pit	
Water Main	
Water Conduit	
Water Service Point of Entry	
Underground Electricity, Street Light, Electricity Pillar & NBN	
Developer Fencing	
Concrete Pathway	
Zero Setback Building Line	
Landscape Street Tree	
Indicative Building Envelope	
Bin Pads	
Indicative Parking Access Location	

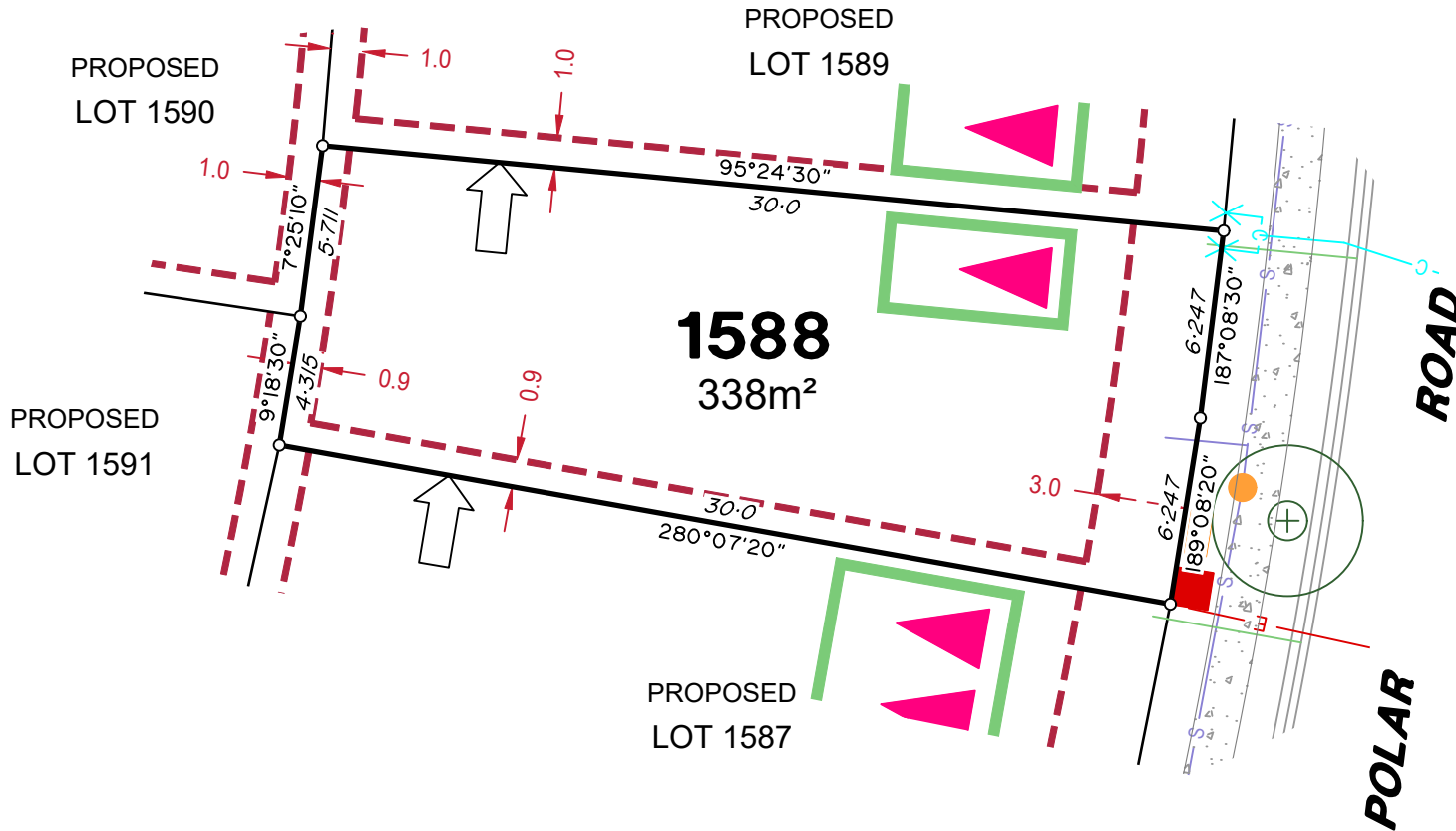

ADDITIONAL NOTES:

Allotments used as Multiple Residential Allotments in accordance with the approved Plan of Development may have a reduced primary road setback to 3.0metres as noted on the Plan of Development Table.

Compaction of any fill material placed on this site shall be completed to level one inspection and testing services in accordance with AS3798-2007.

Location of sewer, roofwater, stormwater, water reticulation and electricity lines, manholes and pits are those shown on engineering design drawings, supplied by Peak Urban and may differ from the as-constructed location.

Plan of Development information Supplied by RPS Group PLC.

Copyright © Veris Australia Pty Ltd
December 2024

Plot Date: 11 Dec, 2024
 Computer File Ref: 30109-St4H-SP-(A).dwg



LEGEND

Rock Retaining Wall shown as:-		
Sleeper Retaining Wall shown as:-		
Landscape Retaining Wall shown as:-		
Sewer line		
Sewer Manhole		
Roofwater Drainage line and Catch Pit		
Stormwater Drainage Line		
Stormwater Manhole		
Stormwater Pit		
Water Main		
Water Conduit		
Water Service Point of Entry		
Underground Electricity, Street Light, Electricity Pillar & NBN		
Developer Fencing		
Concrete Pathway		
Zero Setback Building Line		
		Indicative Building Envelope
		Bin Pads
		Indicative Parking Access Location

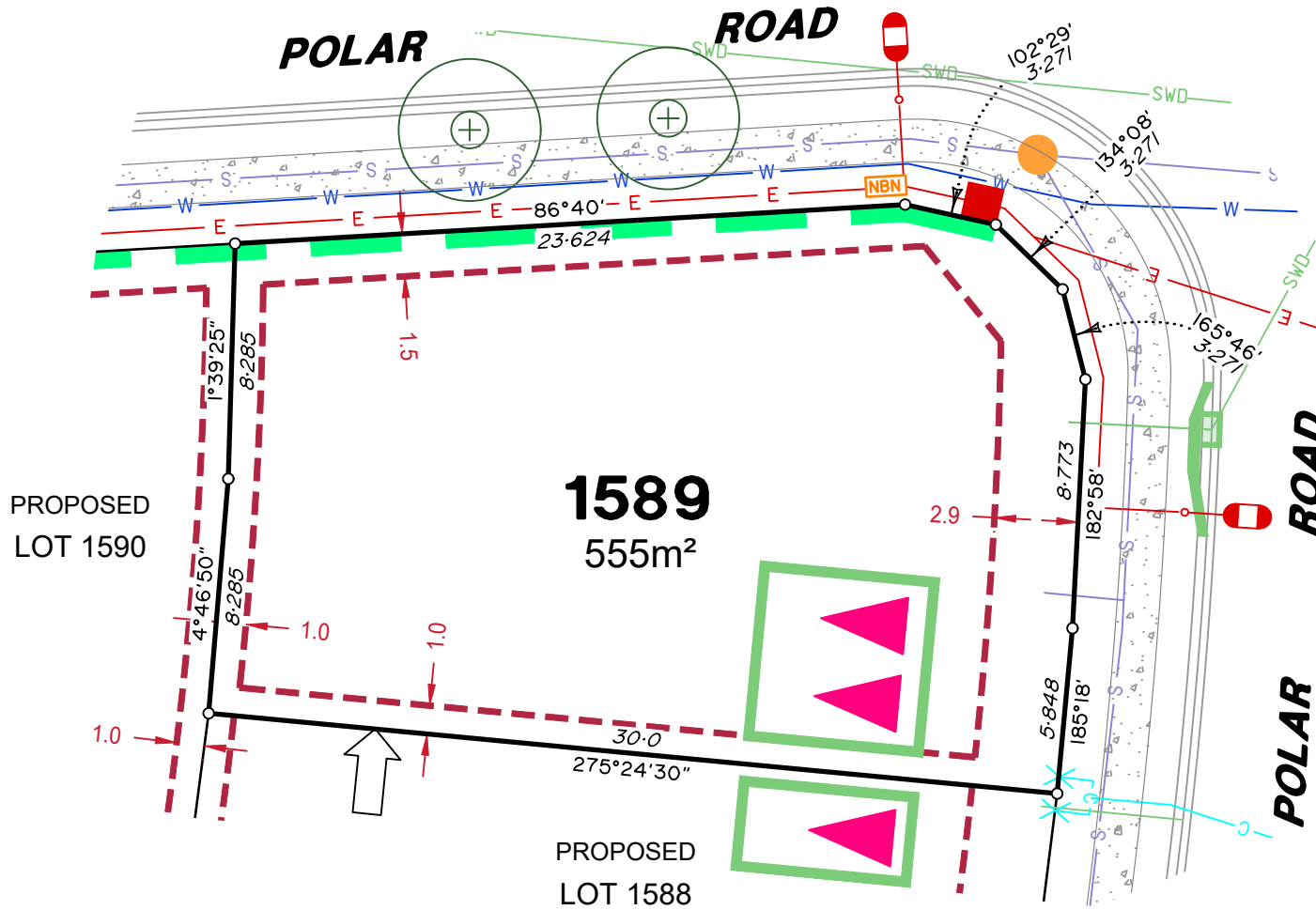

ADDITIONAL NOTES:

Allotments used as Multiple Residential Allotments in accordance with the approved Plan of Development may have a reduced primary road setback to 3.0metres as noted on the Plan of Development Table.

Compaction of any fill material placed on this site shall be completed to level one inspection and testing services in accordance with AS3798-2007.

Location of sewer, roofwater, stormwater, water reticulation and electricity lines, manholes and pits are those shown on engineering design drawings, supplied by Peak Urban and may differ from the as-constructed location.

Plan of Development information Supplied by RPS Group PLC.

Copyright © Veris Australia Pty Ltd
December 2024

Plot Date: 11 Dec, 2024
 Computer File Ref: 30109-St4H-SP-(A).dwg

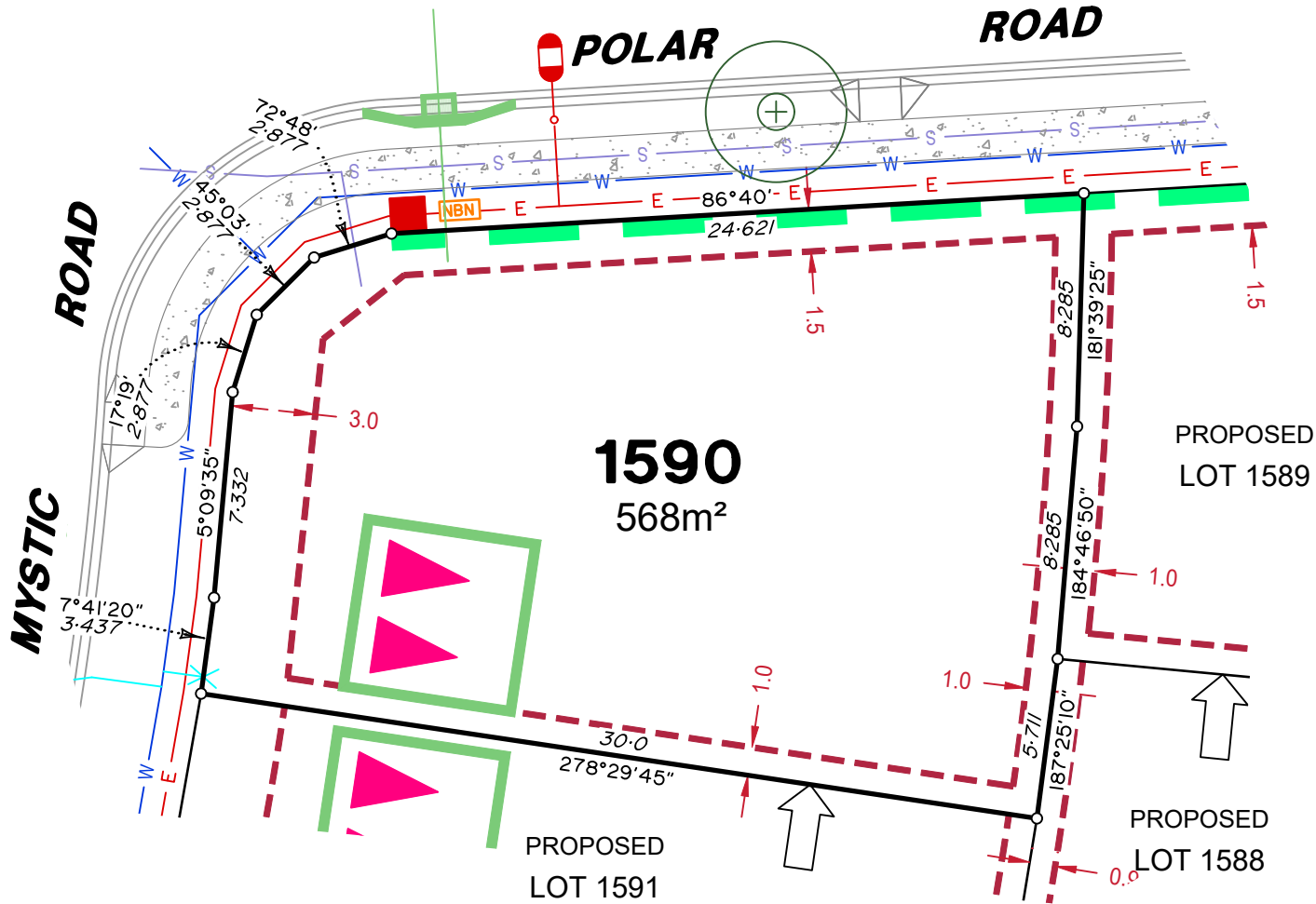

LEGEND

Rock Retaining Wall shown as:-	
Sleeper Retaining Wall shown as:-	
Landscape Retaining Wall shown as:-	
Sewer line	
Sewer Manhole	
Roofwater Drainage line and Catch Pit	
Stormwater Drainage Line	
Stormwater Manhole	
Stormwater Pit	
Water Main	
Water Conduit	
Water Service Point of Entry	
Underground Electricity, Street Light, Electricity Pillar & NBN	
Developer Fencing	
Concrete Pathway	
Zero Setback Building Line	
Landscape Street Tree	
Indicative Building Envelope	
Bin Pads	
Indicative Parking Access Location	

ADDITIONAL NOTES:

Allotments used as Multiple Residential Allotments in accordance with the approved Plan of Development may have a reduced primary road setback to 3.0metres as noted on the Plan of Development Table.

Compaction of any fill material placed on this site shall be completed to level one inspection and testing services in accordance with AS3798-2007.

Location of sewer, roofwater, stormwater, water reticulation and electricity lines, manholes and pits are those shown on engineering design drawings, supplied by Peak Urban and may differ from the as-constructed location.

Plan of Development information Supplied by RPS Group PLC.

Copyright © Veris Australia Pty Ltd
December 2024

Plot Date: 11 Dec, 2024
Computer File Ref: 30109-St4H-SP-(A).dwg

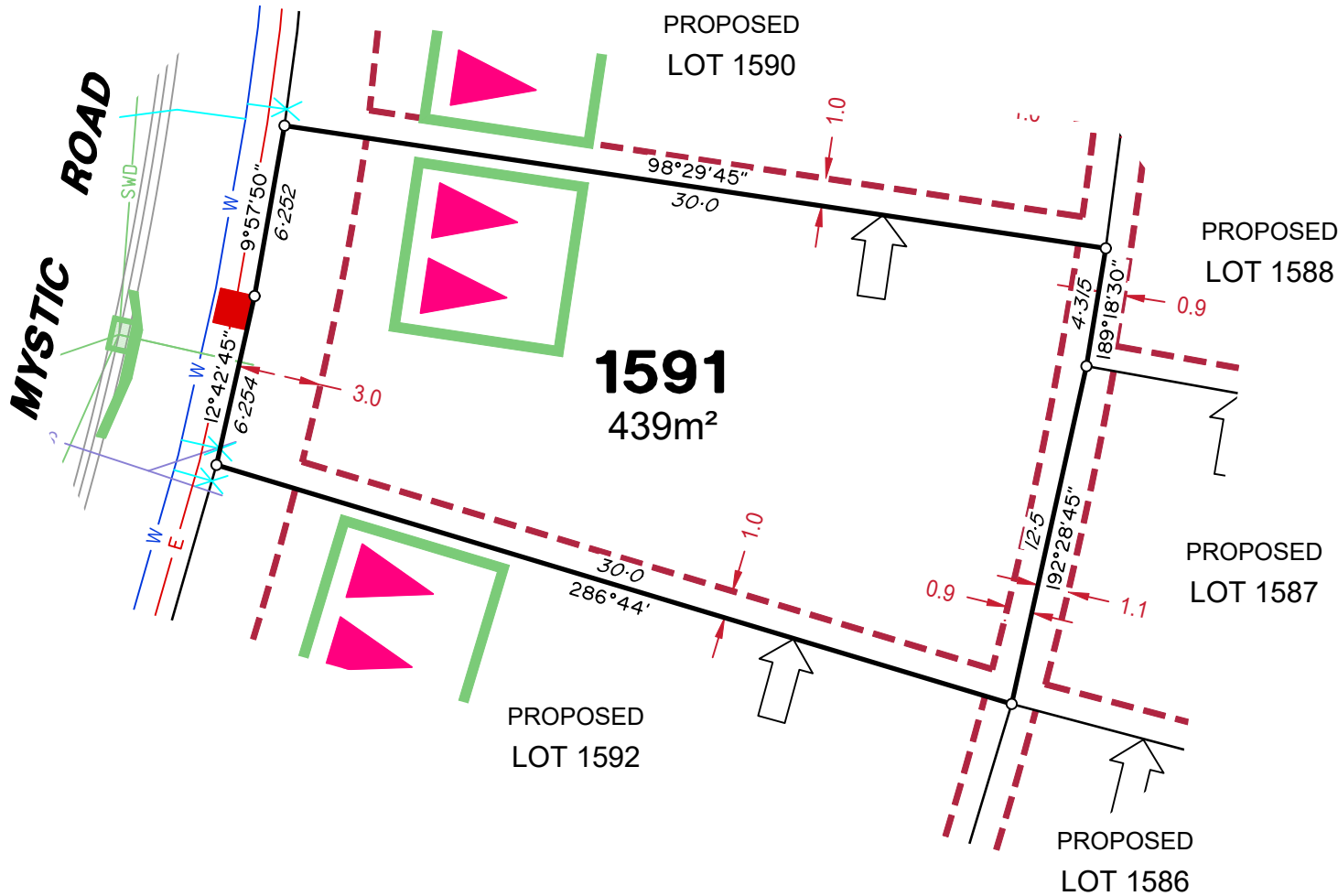

LEGEND

Rock Retaining Wall shown as:-	
Sleeper Retaining Wall shown as:-	
Landscape Retaining Wall shown as:-	
Sewer line	
Sewer Manhole	
Roofwater Drainage line and Catch Pit	
Stormwater Drainage Line	
Stormwater Manhole	
Stormwater Pit	
Water Main	
Water Conduit	
Water Service Point of Entry	
Underground Electricity, Street Light, Electricity Pillar & NBN	
Developer Fencing	
Concrete Pathway	
Zero Setback Building Line	
Landscape Street Tree	
Indicative Building Envelope	
Bin Pads	
Indicative Parking Access Location	

ADDITIONAL NOTES:

Allotments used as Multiple Residential Allotments in accordance with the approved Plan of Development may have a reduced primary road setback to 3.0metres as noted on the Plan of Development Table.

Compaction of any fill material placed on this site shall be completed to level one inspection and testing services in accordance with AS3798-2007.

Location of sewer, roofwater, stormwater, water reticulation and electricity lines, manholes and pits are those shown on engineering design drawings, supplied by Peak Urban and may differ from the as-constructed location.

Plan of Development information Supplied by RPS Group PLC.

Copyright © Veris Australia Pty Ltd
December 2024

Plot Date: 11 Dec, 2024
Computer File Ref: 30109-St4H-SP-(A).dwg

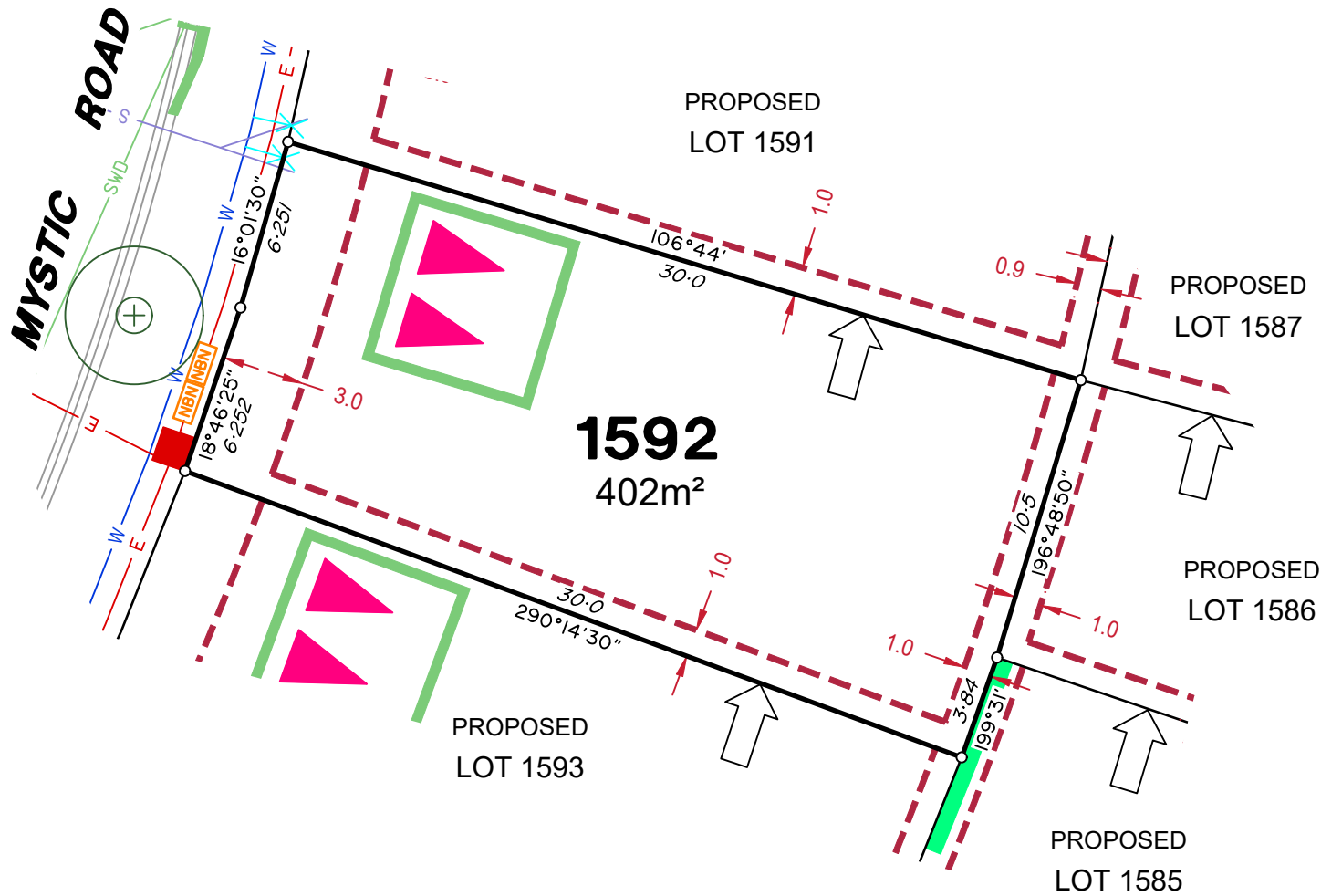

LEGEND

Rock Retaining Wall shown as:-	
Sleeper Retaining Wall shown as:-	
Landscape Retaining Wall shown as:-	
Sewer line	
Sewer Manhole	
Roofwater Drainage line and Catch Pit	
Stormwater Drainage Line	
Stormwater Manhole	
Stormwater Pit	
Water Main	
Water Conduit	
Water Service Point of Entry	
Underground Electricity, Street Light, Electricity Pillar & NBN	
Developer Fencing	
Concrete Pathway	
Zero Setback Building Line	
Landscape Street Tree	
Indicative Building Envelope	
Bin Pads	
Indicative Parking Access Location	

ADDITIONAL NOTES:

Allotments used as Multiple Residential Allotments in accordance with the approved Plan of Development may have a reduced primary road setback to 3.0metres as noted on the Plan of Development Table.

Compaction of any fill material placed on this site shall be completed to level one inspection and testing services in accordance with AS3798-2007.

Location of sewer, roofwater, stormwater, water reticulation and electricity lines, manholes and pits are those shown on engineering design drawings, supplied by Peak Urban and may differ from the as-constructed location.

Plan of Development information Supplied by RPS Group PLC.

Copyright © Veris Australia Pty Ltd
December 2024

Plot Date: 11 Dec, 2024
Computer File Ref: 30109-SI4H-SP-(A).dwg

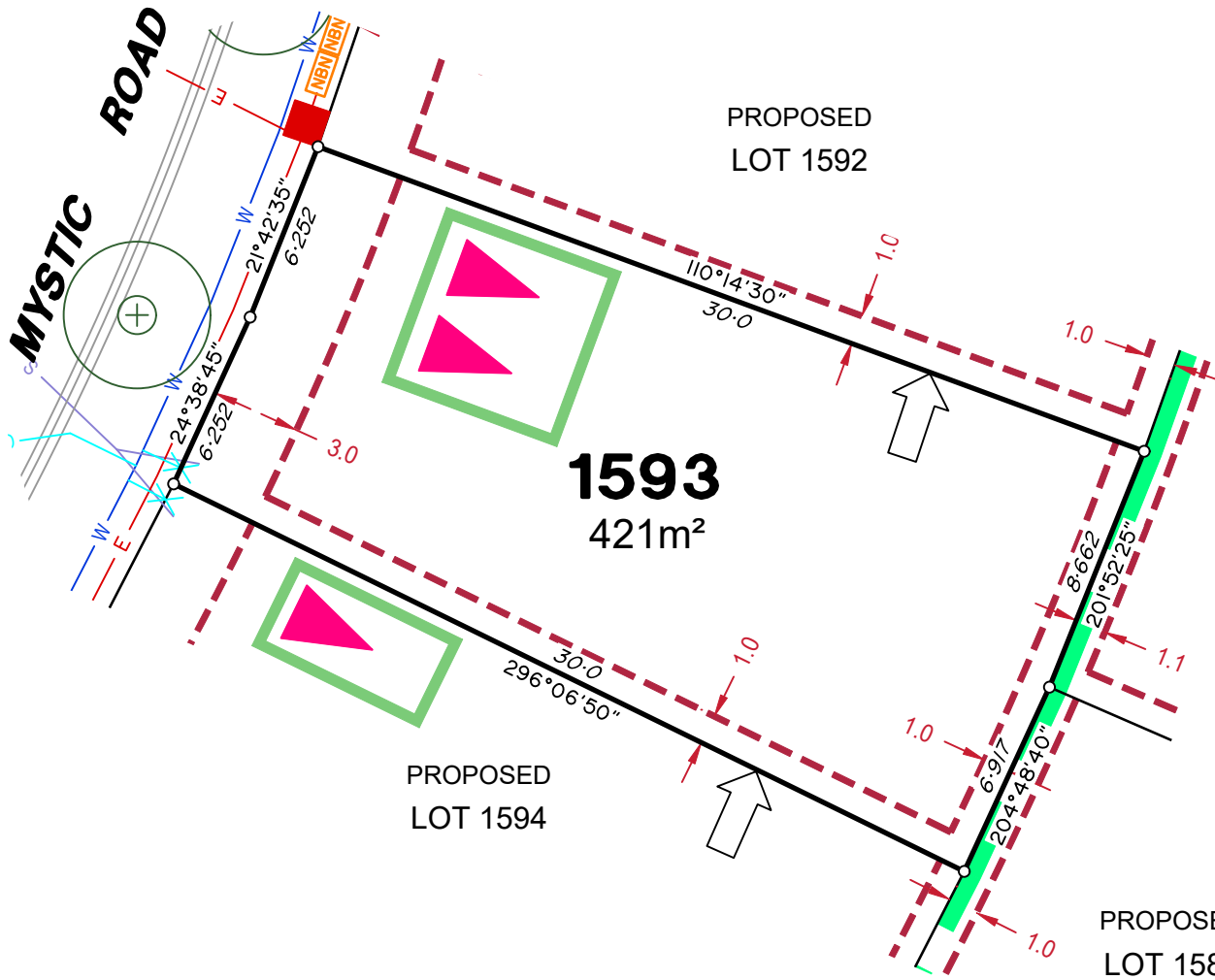

LEGEND

Rock Retaining Wall shown as:-	
Sleeper Retaining Wall shown as:-	
Landscape Retaining Wall shown as:-	
Sewer line	
Sewer Manhole	
Roofwater Drainage line and Catch Pit	
Stormwater Drainage Line	
Stormwater Manhole	
Stormwater Pit	
Water Main	
Water Conduit	
Water Service Point of Entry	
Underground Electricity, Street Light, Electricity Pillar & NBN	
Developer Fencing	
Concrete Pathway	
Zero Setback Building Line	
Landscape Street Tree	
Indicative Building Envelope	
Bin Pads	
Indicative Parking Access Location	

ADDITIONAL NOTES:

Allotments used as Multiple Residential Allotments in accordance with the approved Plan of Development may have a reduced primary road setback to 3.0metres as noted on the Plan of Development Table.

Compaction of any fill material placed on this site shall be completed to level one inspection and testing services in accordance with AS3798-2007.

Location of sewer, roofwater, stormwater, water reticulation and electricity lines, manholes and pits are those shown on engineering design drawings, supplied by Peak Urban and may differ from the as-constructed location.

Plan of Development information Supplied by RPS Group PLC.

Copyright © Veris Australia Pty Ltd
December 2024

Plot Date: 11 Dec, 2024
Computer File Ref: 30109-S4H-SP-(A).dwg

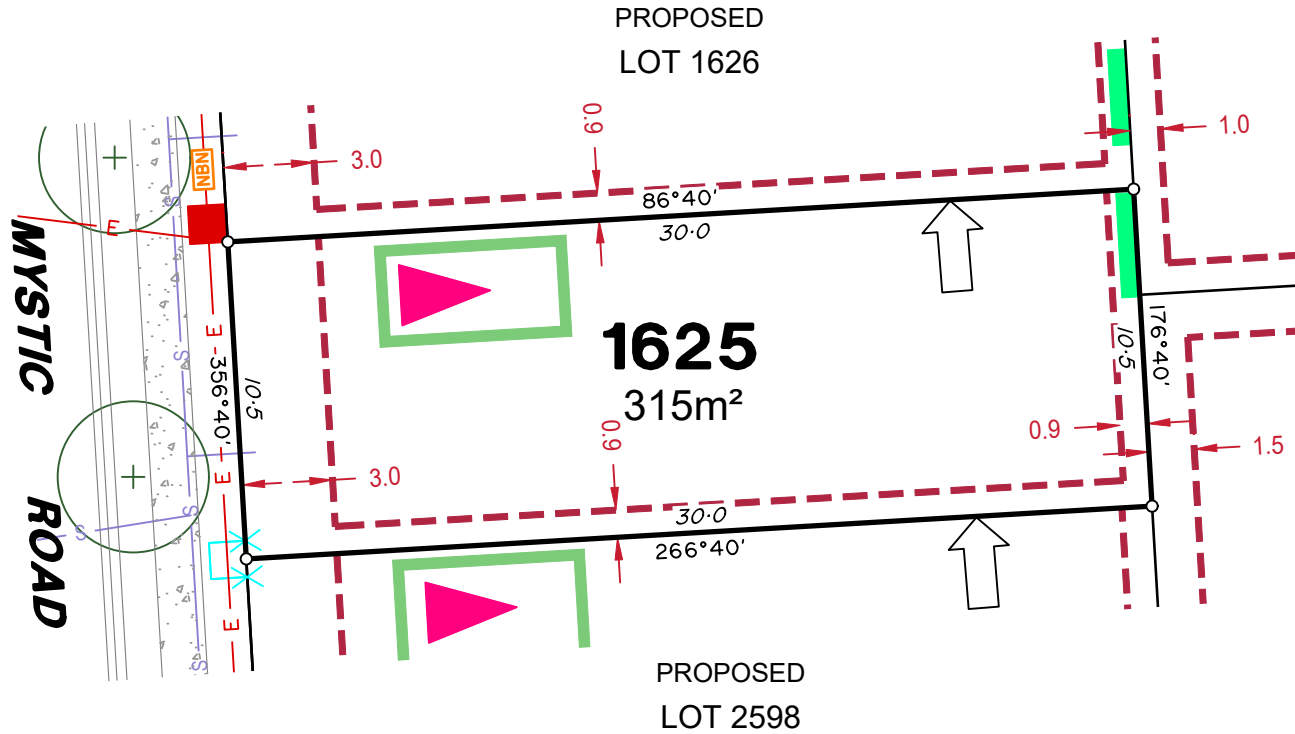

LEGEND

Rock Retaining Wall shown as:-	
Sleeper Retaining Wall shown as:-	
Landscape Retaining Wall shown as:-	
Sewer line	
Sewer Manhole	
Roofwater Drainage line and Catch Pit	
Stormwater Drainage Line	
Stormwater Manhole	
Stormwater Pit	
Water Main	
Water Conduit	
Water Service Point of Entry	
Underground Electricity, Street Light, Electricity Pillar & NBN	
Developer Fencing	
Concrete Pathway	
Zero Setback Building Line	
Landscape Street Tree	
Indicative Building Envelope	
Bin Pads	
Indicative Parking Access Location	

ADDITIONAL NOTES:

Allotments used as Multiple Residential Allotments in accordance with the approved Plan of Development may have a reduced primary road setback to 3.0metres as noted on the Plan of Development Table.

Compaction of any fill material placed on this site shall be completed to level one inspection and testing services in accordance with AS3798-2007.

Location of sewer, roofwater, stormwater, water reticulation and electricity lines, manholes and pits are those shown on engineering design drawings, supplied by Peak Urban and may differ from the as-constructed location.

Plan of Development information Supplied by RPS Group PLC.

Copyright © Veris Australia Pty Ltd
December 2024

Plot Date: 11 Dec, 2024
Computer File Ref: 30109-St4H-SP-(A).dwg



LEGEND

Rock Retaining Wall shown as:-	
Sleeper Retaining Wall shown as:-	
Landscape Retaining Wall shown as:-	
Sewer line	
Sewer Manhole	
Roofwater Drainage line and Catch Pit	
Stormwater Drainage Line	
Stormwater Manhole	
Stormwater Pit	
Water Main	
Water Conduit	
Water Service Point of Entry	
Underground Electricity, Street Light, Electricity Pillar & NBN	
Developer Fencing	
Concrete Pathway	
Zero Setback Building Line	
Landscape Street Tree	
Indicative Building Envelope	
Bin Pads	
Indicative Parking Access Location	

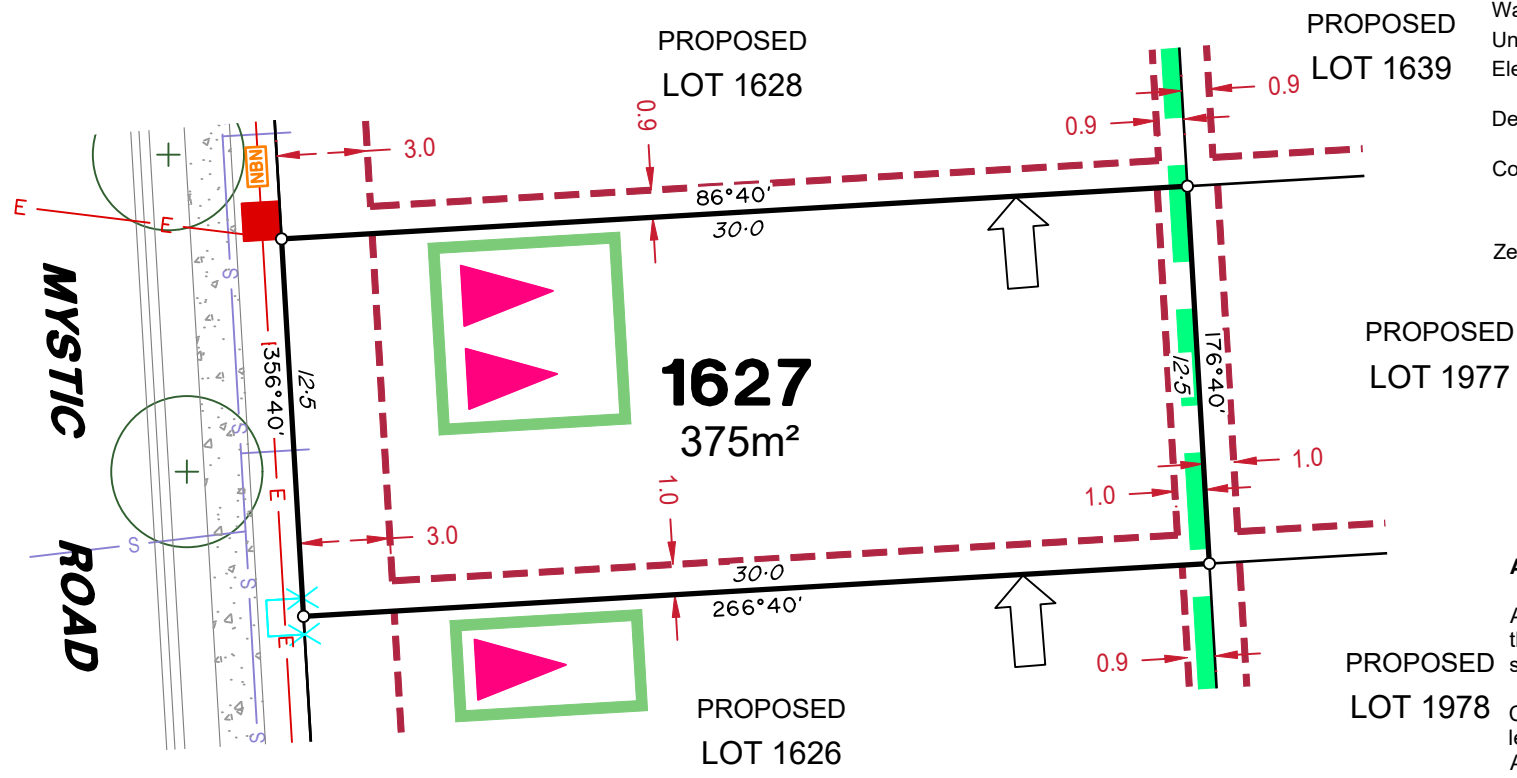

ADDITIONAL NOTES:

Allotments used as Multiple Residential Allotments in accordance with the approved Plan of Development may have a reduced primary road setback to 3.0metres as noted on the Plan of Development Table.

Compaction of any fill material placed on this site shall be completed to level one inspection and testing services in accordance with AS3798-2007.

Location of sewer, roofwater, stormwater, water reticulation and electricity lines, manholes and pits are those shown on engineering design drawings, supplied by Peak Urban and may differ from the as-constructed location.

Plan of Development information Supplied by RPS Group PLC.

Copyright © Veris Australia Pty Ltd
December 2024

Plot Date: 11 Dec, 2024
 Computer File Ref: 30109-St4H-SP-(A).dwg



LEGEND

Rock Retaining Wall shown as:-	
Sleeper Retaining Wall shown as:-	
Landscape Retaining Wall shown as:-	
Sewer line	
Sewer Manhole	
Roofwater Drainage line and Catch Pit	
Stormwater Drainage Line	
Stormwater Manhole	
Stormwater Pit	
Water Main	
Water Conduit	
Water Service Point of Entry	
Underground Electricity, Street Light, Electricity Pillar & NBN	
Developer Fencing	
Concrete Pathway	
Zero Setback Building Line	
Landscape Street Tree	
Indicative Building Envelope	
Bin Pads	
Indicative Parking Access Location	

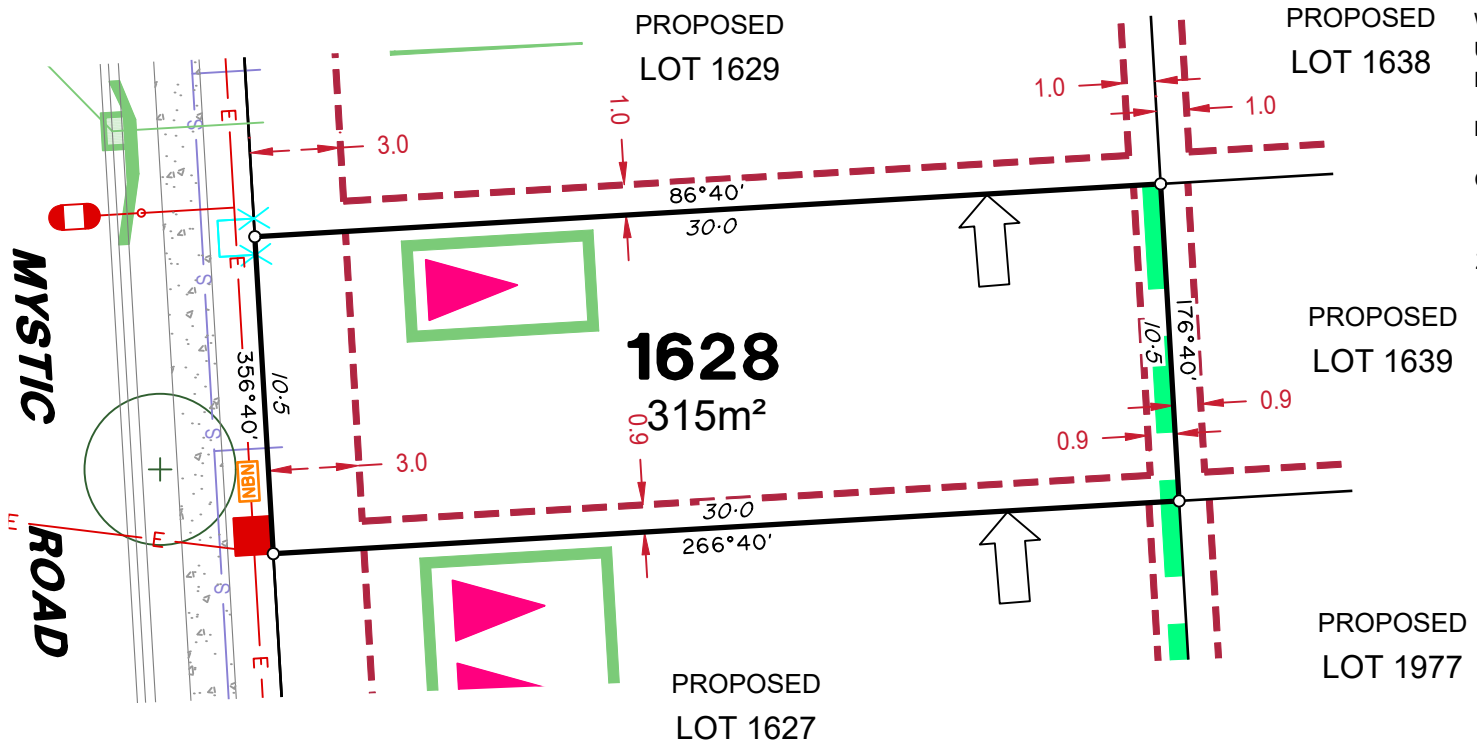

ADDITIONAL NOTES:

Allotments used as Multiple Residential Allotments in accordance with the approved Plan of Development may have a reduced primary road setback to 3.0metres as noted on the Plan of Development Table.

Compaction of any fill material placed on this site shall be completed to level one inspection and testing services in accordance with AS3798-2007.

Location of sewer, roofwater, stormwater, water reticulation and electricity lines, manholes and pits are those shown on engineering design drawings, supplied by Peak Urban and may differ from the as-constructed location.

Plan of Development information Supplied by RPS Group PLC.

Copyright © Veris Australia Pty Ltd
December 2024

Plot Date: 11 Dec, 2024
Computer File Ref: 30109-St4H-SP-(A).dwg

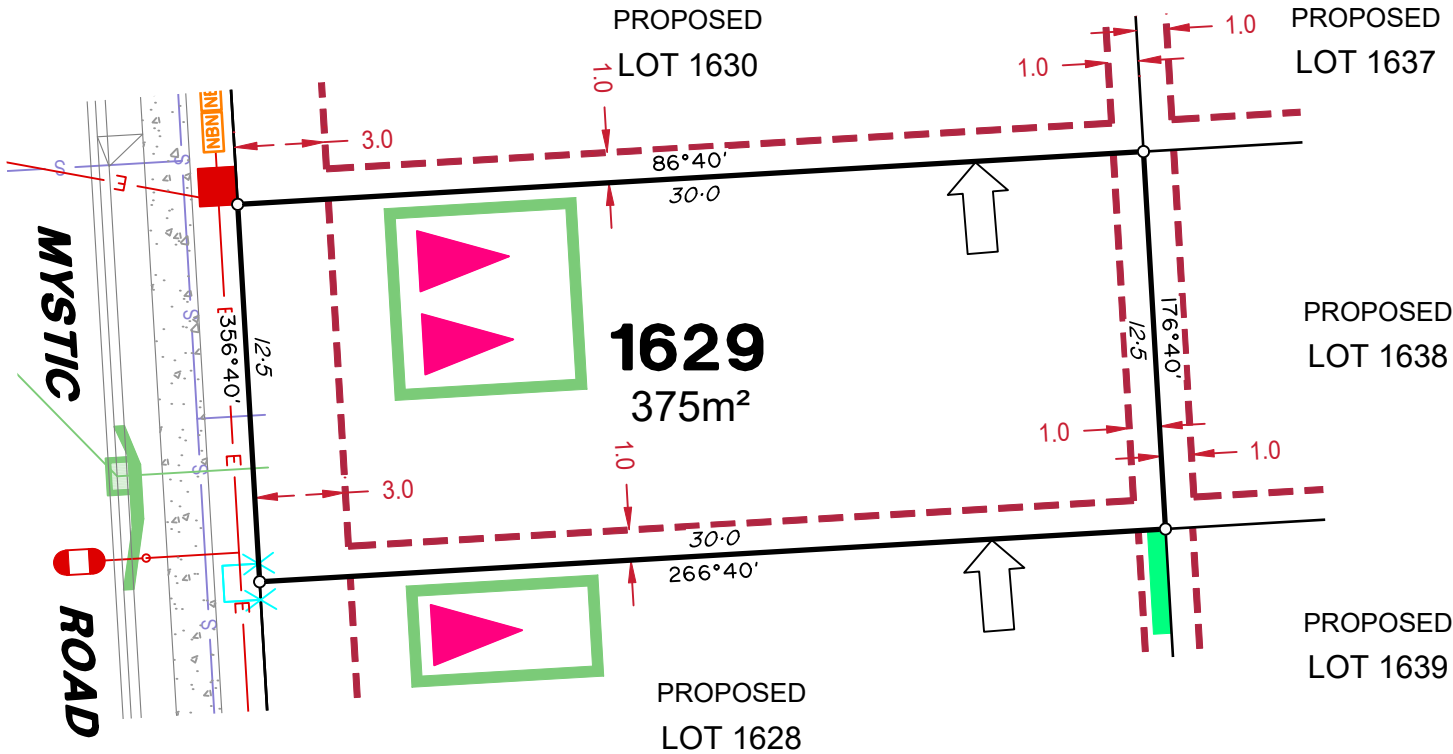

LEGEND

Rock Retaining Wall shown as:-	
Sleeper Retaining Wall shown as:-	
Landscape Retaining Wall shown as:-	
Sewer line	
Sewer Manhole	
Roofwater Drainage line and Catch Pit	
Stormwater Drainage Line	
Stormwater Manhole	
Stormwater Pit	
Water Main	
Water Conduit	
Water Service Point of Entry	
Underground Electricity, Street Light, Electricity Pillar & NBN	
Developer Fencing	
Concrete Pathway	
Zero Setback Building Line	
Landscape Street Tree	
Indicative Building Envelope	
Bin Pads	
Indicative Parking Access Location	

ADDITIONAL NOTES:

Allotments used as Multiple Residential Allotments in accordance with the approved Plan of Development may have a reduced primary road setback to 3.0metres as noted on the Plan of Development Table.

Compaction of any fill material placed on this site shall be completed to level one inspection and testing services in accordance with AS3798-2007.

Location of sewer, roofwater, stormwater, water reticulation and electricity lines, manholes and pits are those shown on engineering design drawings, supplied by Peak Urban and may differ from the as-constructed location.

Plan of Development information Supplied by RPS Group PLC.

Copyright © Veris Australia Pty Ltd
December 2024

Plot Date: 11 Dec, 2024
Computer File Ref: 30109-St4H-SP-(A).dwg



MYSTIC ROAD

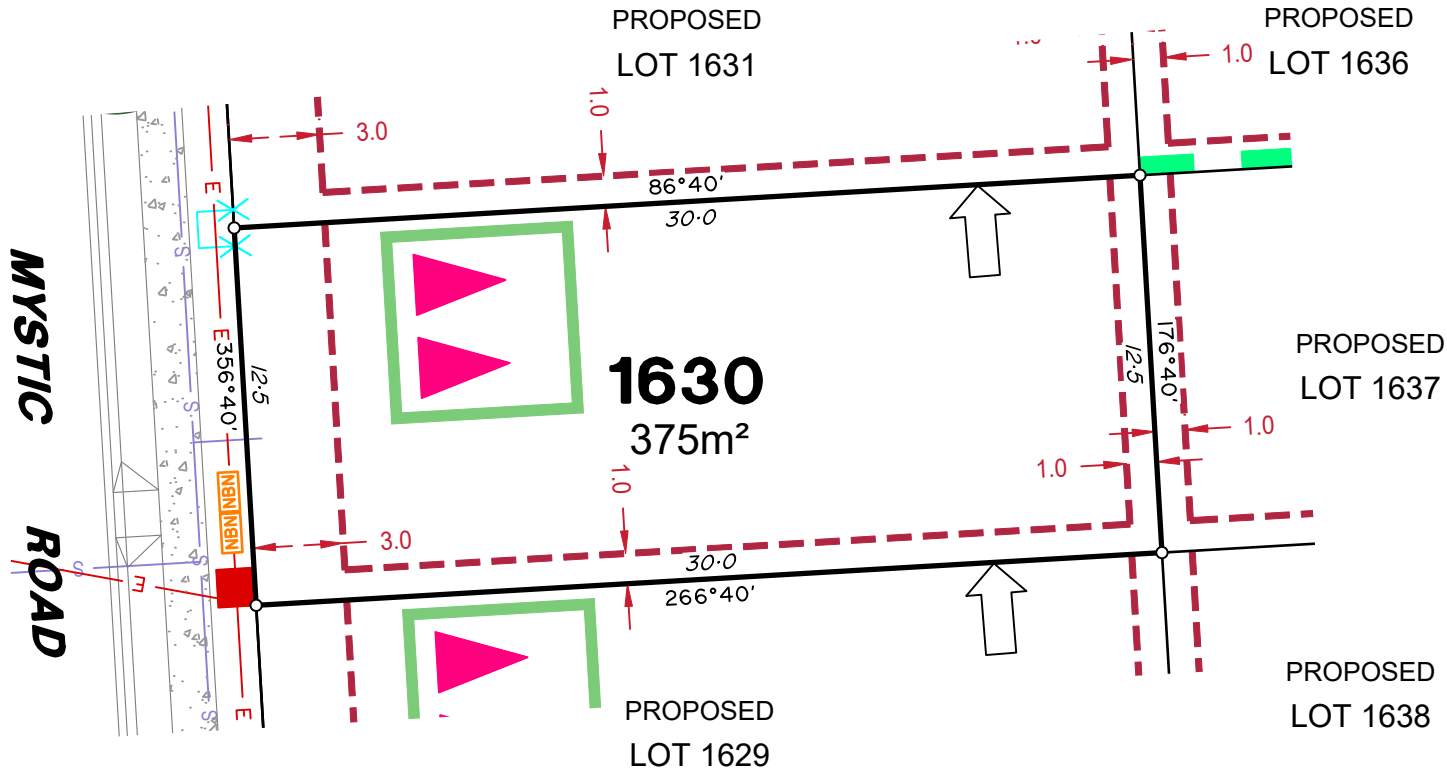

LEGEND

Rock Retaining Wall shown as:-	
Sleeper Retaining Wall shown as:-	
Landscape Retaining Wall shown as:-	
Sewer line	
Sewer Manhole	
Roofwater Drainage line and Catch Pit	
Stormwater Drainage Line	
Stormwater Manhole	
Stormwater Pit	
Water Main	
Water Conduit	
Water Service Point of Entry	
Underground Electricity, Street Light, Electricity Pillar & NBN	
Developer Fencing	
Concrete Pathway	
Zero Setback Building Line	
Landscape Street Tree	
Indicative Building Envelope	
Bin Pads	
Indicative Parking Access Location	

ADDITIONAL NOTES:

Allotments used as Multiple Residential Allotments in accordance with the approved Plan of Development may have a reduced primary road setback to 3.0metres as noted on the Plan of Development Table.

Compaction of any fill material placed on this site shall be completed to level one inspection and testing services in accordance with AS3798-2007.

Location of sewer, roofwater, stormwater, water reticulation and electricity lines, manholes and pits are those shown on engineering design drawings, supplied by Peak Urban and may differ from the as-constructed location.

Plan of Development information Supplied by RPS Group PLC.

Copyright © Veris Australia Pty Ltd
December 2024

Plot Date: 11 Dec, 2024
Computer File Ref: 30109-St4H-SP-(A).dwg



MYSTIC ROAD

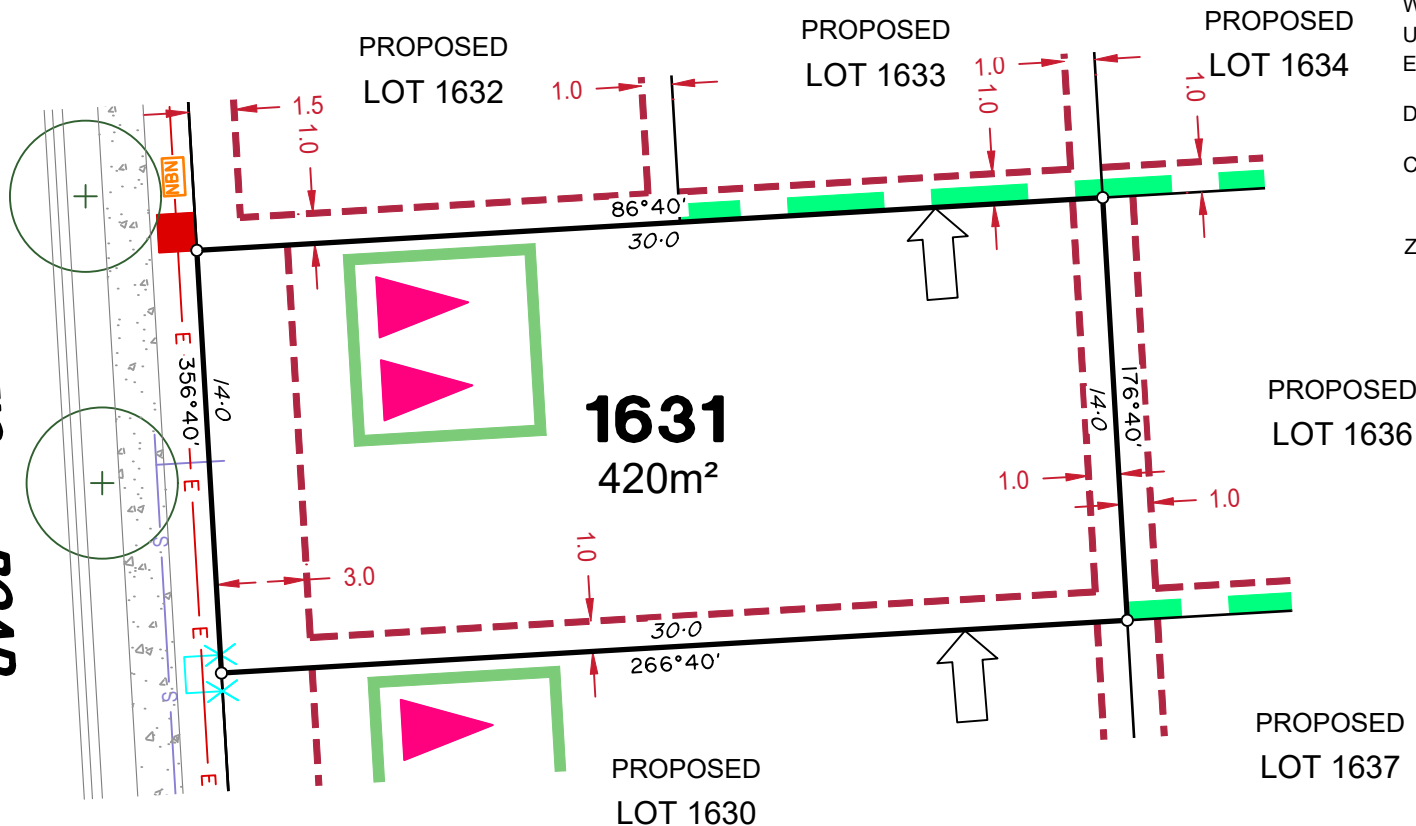

LEGEND

- Rock Retaining Wall shown as:-
- Sleeper Retaining Wall shown as:-
- Landscape Retaining Wall shown as:-
- Sewer line
- Sewer Manhole
- Roofwater Drainage line and Catch Pit
- Stormwater Drainage Line
- Stormwater Manhole
- Stormwater Pit
- Water Main
- Water Conduit
- Water Service Point of Entry
- Underground Electricity, Street Light, Electricity Pillar & NBN
- Developer Fencing
- Concrete Pathway
- Zero Setback Building Line
- Landscape Street Tree
- Indicative Building Envelope
- Bin Pads
- Indicative Parking Access Location

ADDITIONAL NOTES:

Allotments used as Multiple Residential Allotments in accordance with the approved Plan of Development may have a reduced primary road setback to 3.0metres as noted on the Plan of Development Table.

Compaction of any fill material placed on this site shall be completed to level one inspection and testing services in accordance with AS3798-2007.

Location of sewer, roofwater, stormwater, water reticulation and electricity lines, manholes and pits are those shown on engineering design drawings, supplied by Peak Urban and may differ from the as-constructed location.

Plan of Development information Supplied by RPS Group PLC.

Copyright © Veris Australia Pty Ltd
December 2024

Plot Date: 11 Dec, 2024
 Computer File Ref: 30109-St4H-SP-(A).dwg

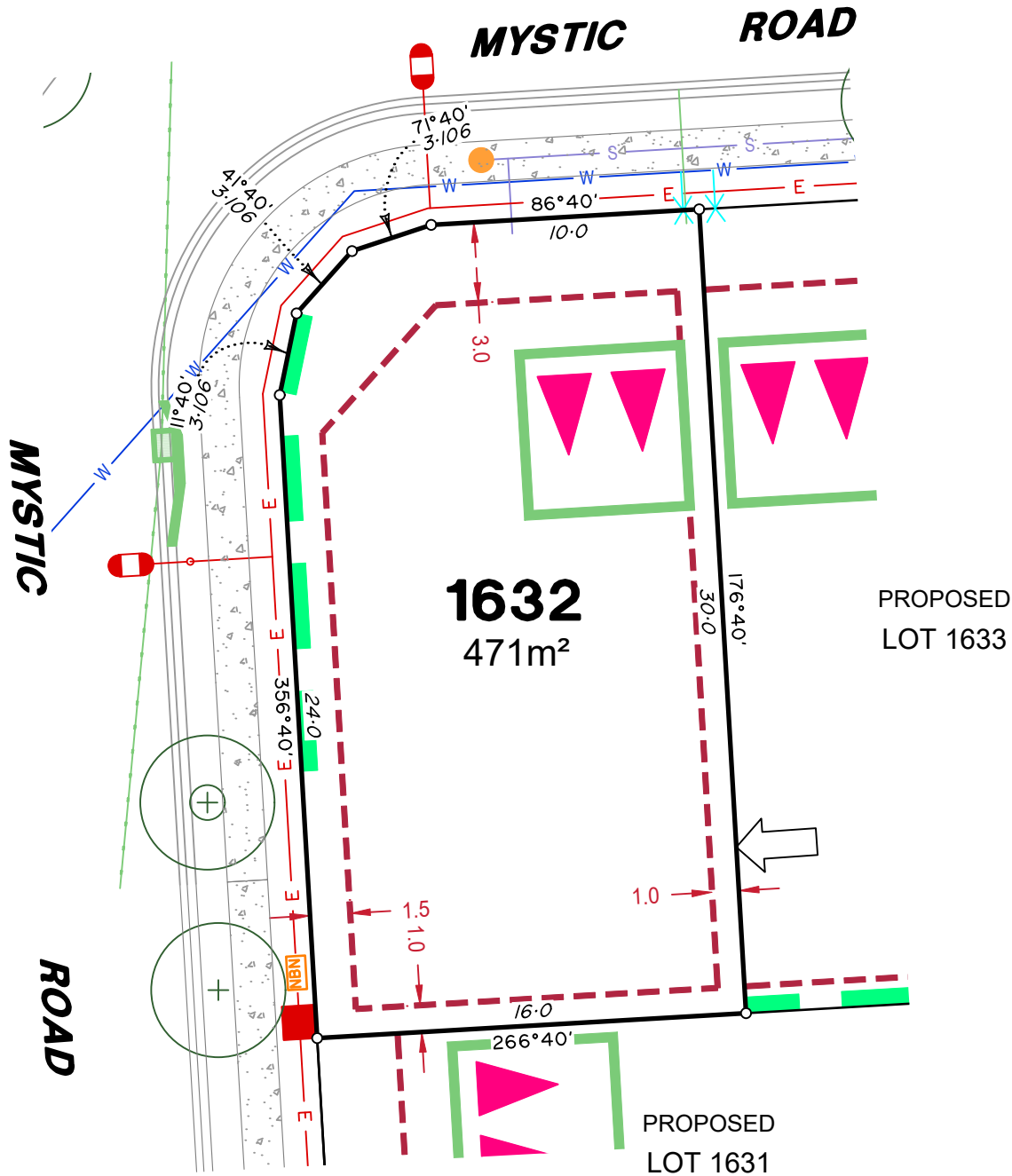

LEGEND

Rock Retaining Wall shown as:-	
Sleeper Retaining Wall shown as:-	
Landscape Retaining Wall shown as:-	
Sewer line	
Sewer Manhole	
Roofwater Drainage line and Catch Pit	
Stormwater Drainage Line	
Stormwater Manhole	
Stormwater Pit	
Water Main	
Water Conduit	
Water Service Point of Entry	
Underground Electricity, Street Light, Electricity Pillar & NBN	
Developer Fencing	
Concrete Pathway	
Zero Setback Building Line	
Landscape Street Tree	
Indicative Building Envelope	
Bin Pads	
Indicative Parking Access Location	

ADDITIONAL NOTES:

Allotments used as Multiple Residential Allotments in accordance with the approved Plan of Development may have a reduced primary road setback to 3.0metres as noted on the Plan of Development Table.

Compaction of any fill material placed on this site shall be completed to level one inspection and testing services in accordance with AS3798-2007.

Location of sewer, roofwater, stormwater, water reticulation and electricity lines, manholes and pits are those shown on engineering design drawings, supplied by Peak Urban and may differ from the as-constructed location.

Plan of Development information Supplied by RPS Group PLC.

Copyright © Veris Australia Pty Ltd
December 2024

Plot Date: 11 Dec, 2024
Computer File Ref: 30109-St4H-SP-(A).dwg



MYSTIC ROAD

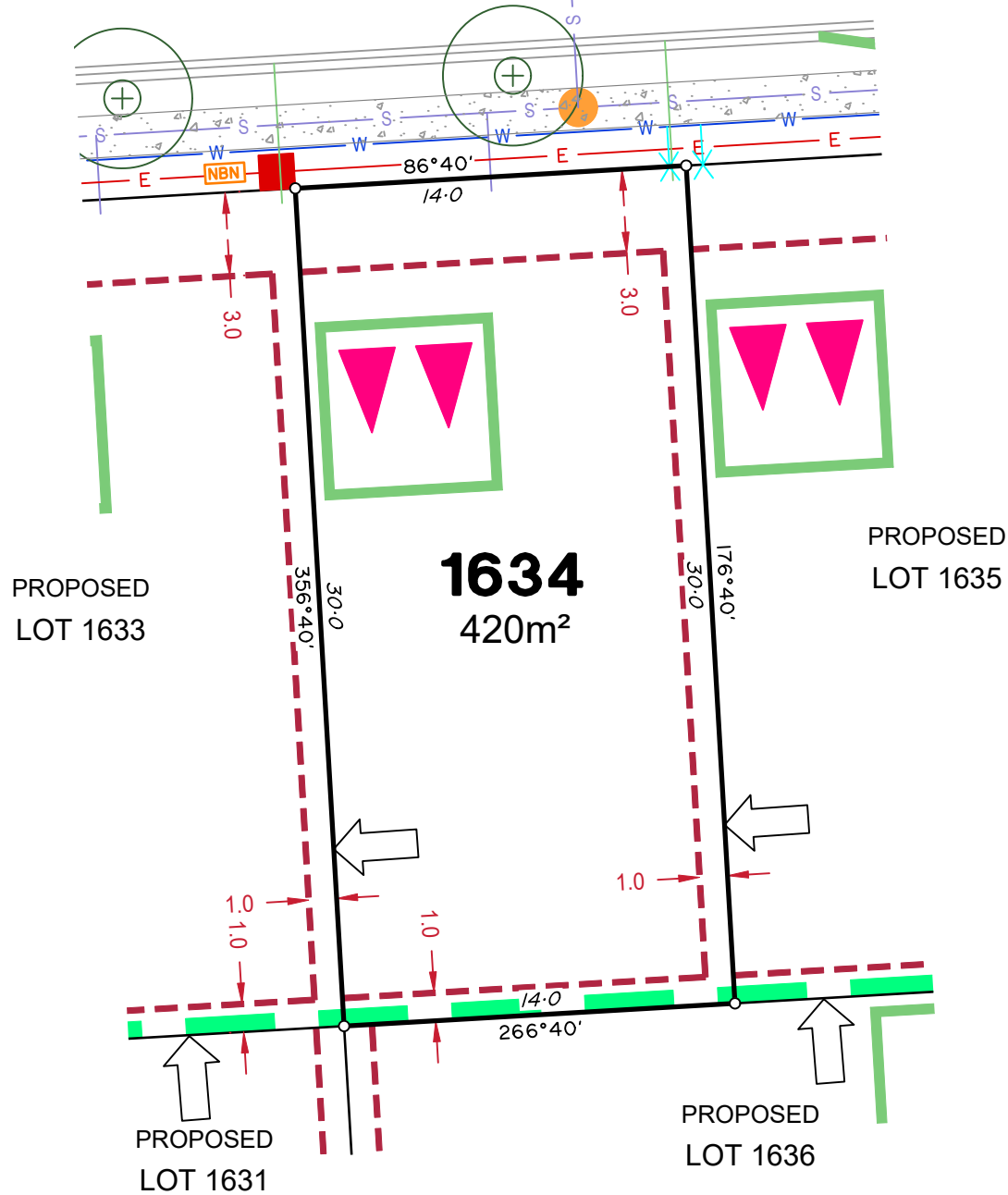

LEGEND

Rock Retaining Wall shown as:-	
Sleeper Retaining Wall shown as:-	
Landscape Retaining Wall shown as:-	
Sewer line	
Sewer Manhole	
Roofwater Drainage line and Catch Pit	
Stormwater Drainage Line	
Stormwater Pit	
Water Main	
Water Conduit	
Water Service Point of Entry	
Underground Electricity, Street Light, Electricity Pillar & NBN	
Developer Fencing	
Concrete Pathway	
Zero Setback Building Line	
Indicative Building Envelope	
Bin Pads	
Indicative Parking Access Location	
Landscape Street Tree	

ADDITIONAL NOTES:

Allotments used as Multiple Residential Allotments in accordance with the approved Plan of Development may have a reduced primary road setback to 3.0metres as noted on the Plan of Development Table.

Compaction of any fill material placed on this site shall be completed to level one inspection and testing services in accordance with AS3798-2007.

Location of sewer, roofwater, stormwater, water reticulation and electricity lines, manholes and pits are those shown on engineering design drawings, supplied by Peak Urban and may differ from the as-constructed location.

Plan of Development information Supplied by RPS Group PLC.

Copyright © Veris Australia Pty Ltd
December 2024

Plot Date: 11 Dec, 2024
Computer File Ref: 30109-St4H-SP-(A).dwg



MYSTIC ROAD

ROAD

REALM COURT

COURT

PROPOSED LOT 1634

1635
471m²

PROPOSED LOT 1636

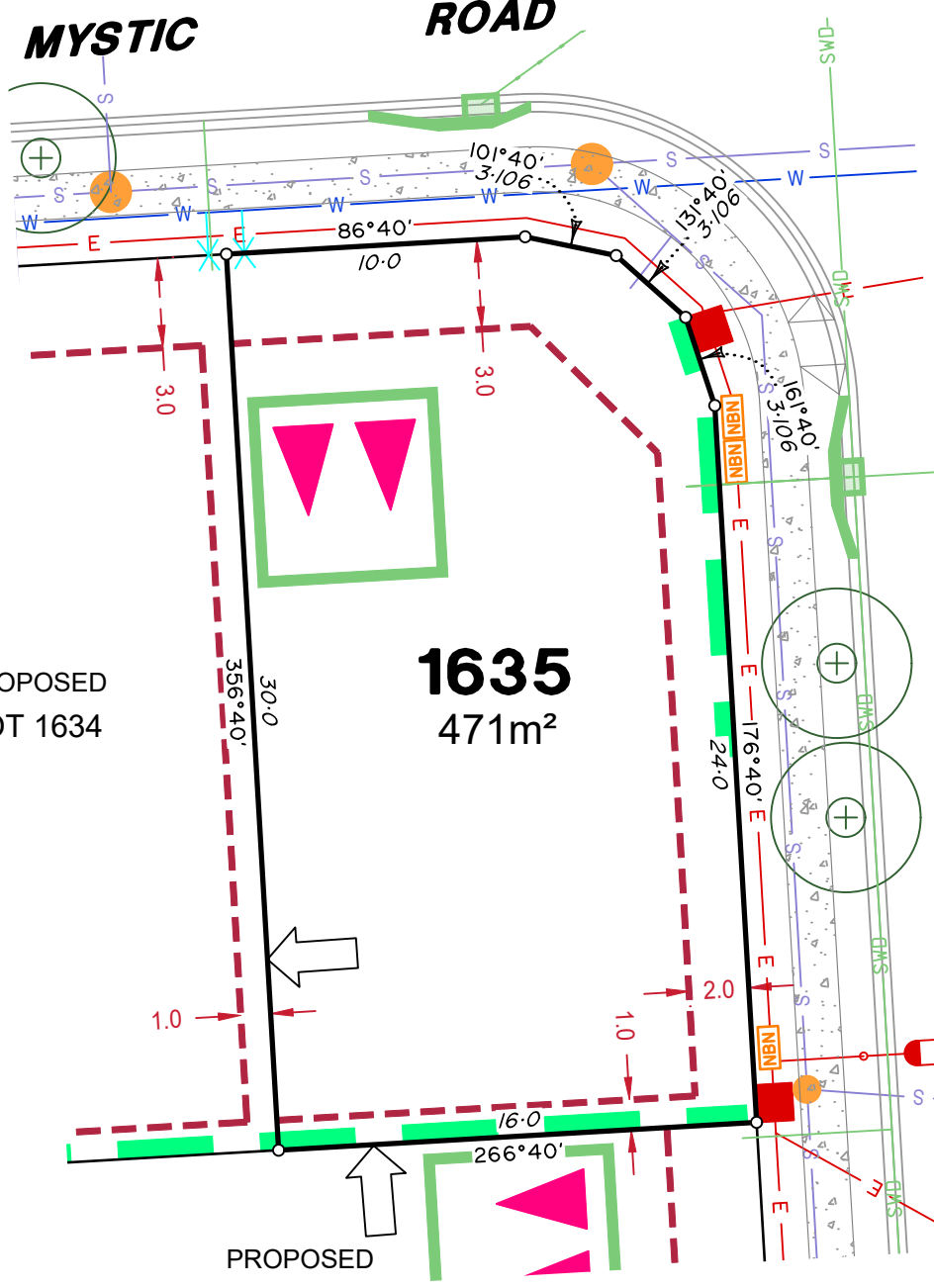

LEGEND

- Rock Retaining Wall shown as:-
- Sleeper Retaining Wall shown as:-
- Landscape Retaining Wall shown as:-
- Sewer line
- Sewer Manhole
- Roofwater Drainage line and Catch Pit
- Stormwater Drainage Line
- Stormwater Manhole
- Stormwater Pit
- Water Main
- Water Conduit
- Water Service Point of Entry
- Underground Electricity, Street Light, Electricity Pillar & NBN
- Developer Fencing
- Concrete Pathway
- Landscape Street Tree
- Zero Setback Building Line
- Indicative Building Envelope
- Bin Pads
- Indicative Parking Access Location

ADDITIONAL NOTES:

Allotments used as Multiple Residential Allotments in accordance with the approved Plan of Development may have a reduced primary road setback to 3.0metres as noted on the Plan of Development Table.

Compaction of any fill material placed on this site shall be completed to level one inspection and testing services in accordance with AS3798-2007.

Location of sewer, roofwater, stormwater, water reticulation and electricity lines, manholes and pits are those shown on engineering design drawings, supplied by Peak Urban and may differ from the as-constructed location.

Plan of Development information Supplied by RPS Group PLC.

Copyright © Veris Australia Pty Ltd
December 2024

Plot Date: 11 Dec, 2024
Computer File Ref: 30109-S4H-SP-(A).dwg

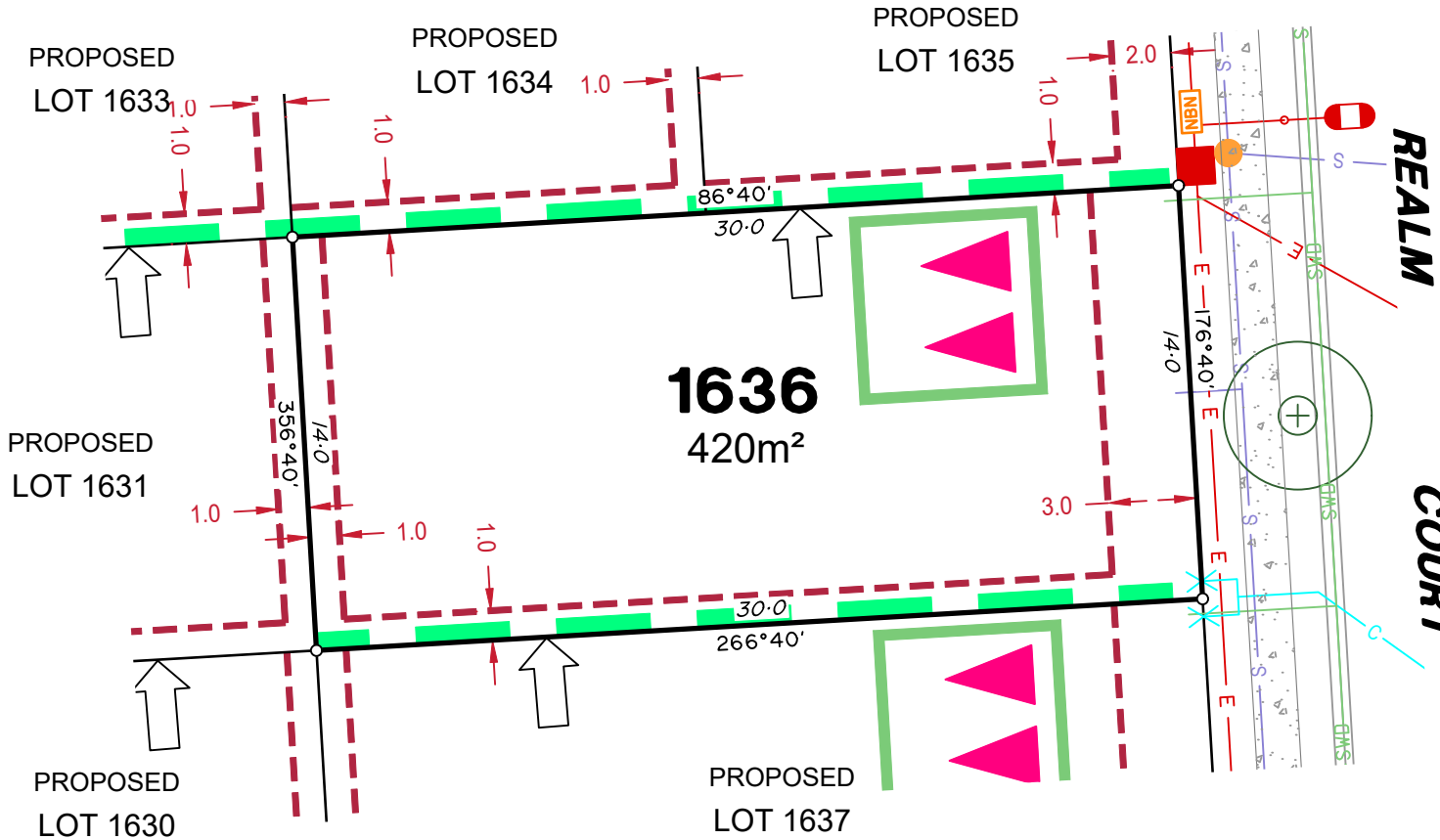

LEGEND

Rock Retaining Wall shown as:-	
Sleeper Retaining Wall shown as:-	
Landscape Retaining Wall shown as:-	
Sewer line	
Sewer Manhole	
Roofwater Drainage line and Catch Pit	
Stormwater Drainage Line	
Stormwater Manhole	
Stormwater Pit	
Water Main	
Water Conduit	
Water Service Point of Entry	
Underground Electricity, Street Light, Electricity Pillar & NBN	
Developer Fencing	
Concrete Pathway	
Zero Setback Building Line	
Landscape Street Tree	
Indicative Building Envelope	
Bin Pads	
Indicative Parking Access Location	

ADDITIONAL NOTES:

Allotments used as Multiple Residential Allotments in accordance with the approved Plan of Development may have a reduced primary road setback to 3.0metres as noted on the Plan of Development Table.

Compaction of any fill material placed on this site shall be completed to level one inspection and testing services in accordance with AS3798-2007.

Location of sewer, roofwater, stormwater, water reticulation and electricity lines, manholes and pits are those shown on engineering design drawings, supplied by Peak Urban and may differ from the as-constructed location.

Plan of Development information Supplied by RPS Group PLC.

Copyright © Veris Australia Pty Ltd
December 2024

Plot Date: 11 Dec, 2024
Computer File Ref: 30109-St4H-SP-(A).dwg



PROPOSED LOT 1631

PROPOSED LOT 1636

PROPOSED LOT 1630

1637
375m²

PROPOSED LOT 1629

PROPOSED LOT 1638

LEGEND

- Rock Retaining Wall shown as:-
- Sleeper Retaining Wall shown as:-
- Landscape Retaining Wall shown as:-
- Sewer line
- Sewer Manhole
- Roofwater Drainage line and Catch Pit
- Stormwater Drainage Line
- Stormwater Manhole
- Stormwater Pit
- Water Main
- Water Conduit
- Water Service Point of Entry
- Underground Electricity, Street Light, Electricity Pillar & NBN
- Developer Fencing
- Concrete Pathway
- Zero Setback Building Line
- Landscape Street Tree
- Indicative Building Envelope
- Bin Pads
- Indicative Parking Access Location

REALM COURT

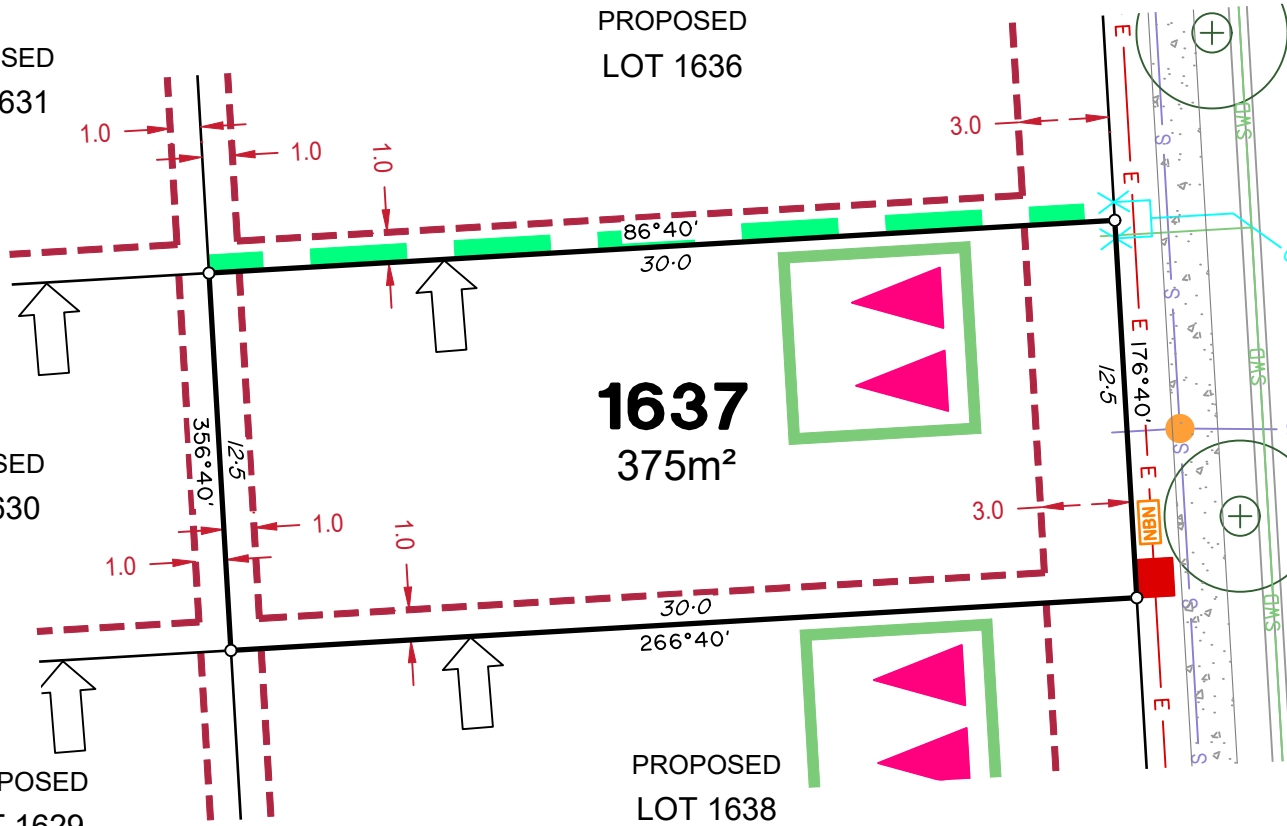

ADDITIONAL NOTES:

Allotments used as Multiple Residential Allotments in accordance with the approved Plan of Development may have a reduced primary road setback to 3.0metres as noted on the Plan of Development Table.

Compaction of any fill material placed on this site shall be completed to level one inspection and testing services in accordance with AS3798-2007.

Location of sewer, roofwater, stormwater, water reticulation and electricity lines, manholes and pits are those shown on engineering design drawings, supplied by Peak Urban and may differ from the as-constructed location.

Plan of Development information Supplied by RPS Group PLC.

Copyright © Veris Australia Pty Ltd
December 2024

Plot Date: 11 Dec, 2024
Computer File Ref: 30109-St4H-SP-(A).dwg



PROPOSED LOT 1630

PROPOSED LOT 1629

PROPOSED LOT 1628

PROPOSED LOT 1637

1638
375m²

PROPOSED LOT 1639

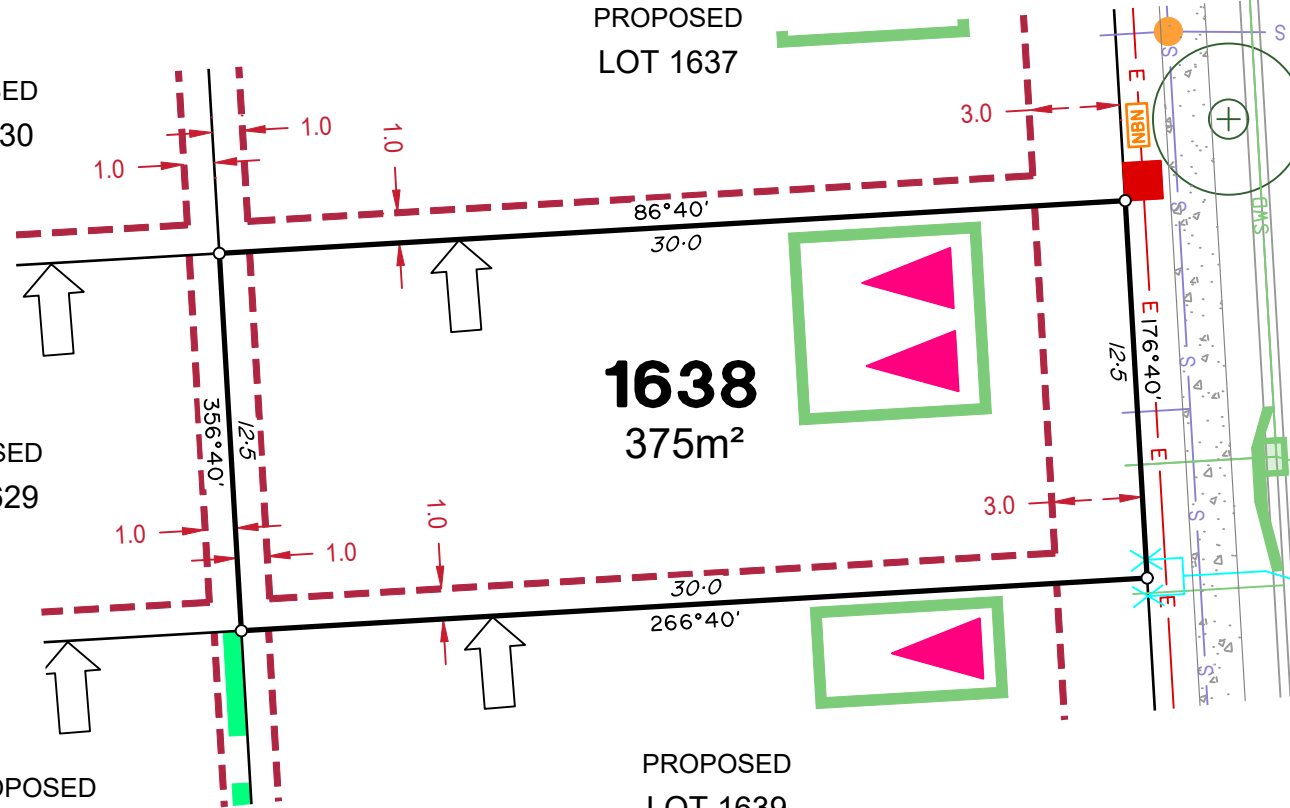

LEGEND

- Rock Retaining Wall shown as:-
- Sleeper Retaining Wall shown as:-
- Landscape Retaining Wall shown as:-
- Sewer line
- Sewer Manhole
- Roofwater Drainage line and Catch Pit
- Stormwater Drainage Line
- Stormwater Manhole
- Stormwater Pit
- Water Main
- Water Conduit
- Water Service Point of Entry
- Underground Electricity, Street Light, Electricity Pillar & NBN
- Developer Fencing
- Concrete Pathway
- Zero Setback Building Line
- Landscape Street Tree
- Indicative Building Envelope
- Bin Pads
- Indicative Parking Access Location

ADDITIONAL NOTES:

Allotments used as Multiple Residential Allotments in accordance with the approved Plan of Development may have a reduced primary road setback to 3.0metres as noted on the Plan of Development Table.

Compaction of any fill material placed on this site shall be completed to level one inspection and testing services in accordance with AS3798-2007.

Location of sewer, roofwater, stormwater, water reticulation and electricity lines, manholes and pits are those shown on engineering design drawings, supplied by Peak Urban and may differ from the as-constructed location.

Plan of Development information Supplied by RPS Group PLC.

Copyright © Veris Australia Pty Ltd
December 2024

Plot Date: 11 Dec, 2024
Computer File Ref: 30109-St4H-SP-(A).dwg



PROPOSED LOT 1629

PROPOSED LOT 1628

PROPOSED LOT 1627

PROPOSED LOT 1638

1639
315m²

PROPOSED LOT 1977

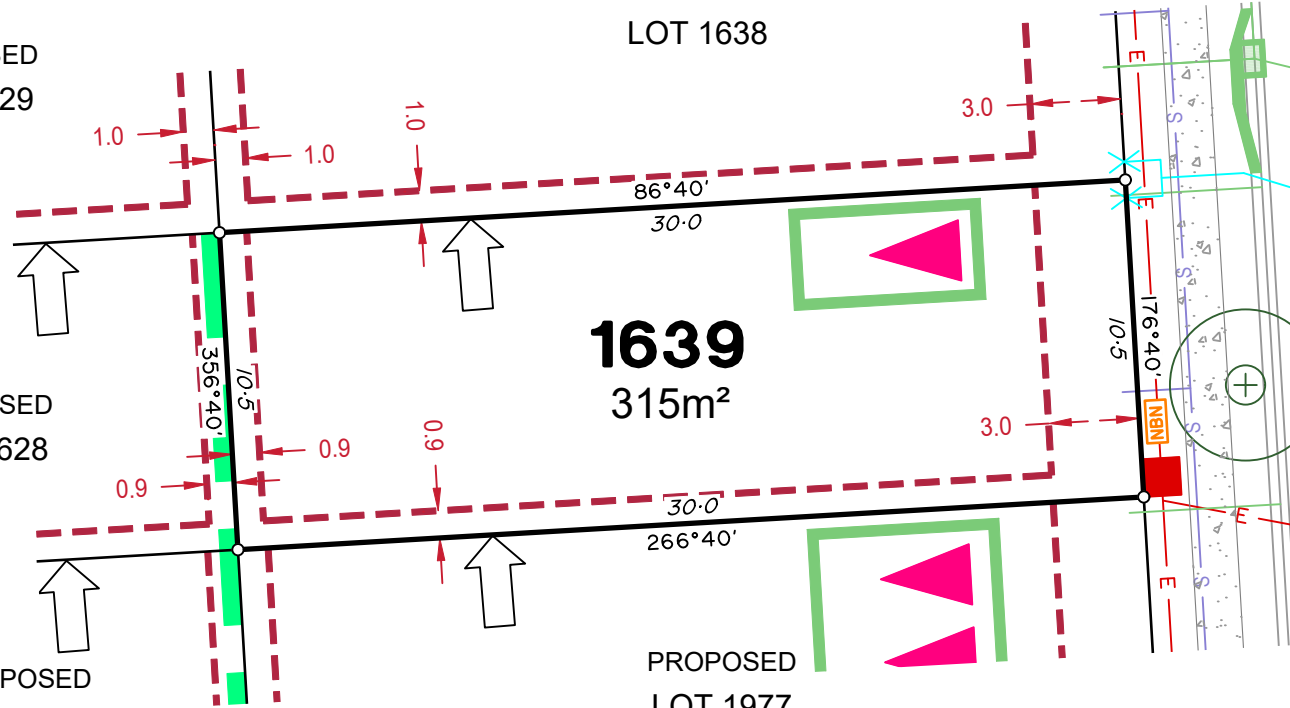

LEGEND

- Rock Retaining Wall shown as:-
- Sleeper Retaining Wall shown as:-
- Landscape Retaining Wall shown as:-
- Sewer line
- Sewer Manhole
- Roofwater Drainage line and Catch Pit
- Stormwater Drainage Line
- Stormwater Manhole
- Stormwater Pit
- Water Main
- Water Conduit
- Water Service Point of Entry
- Underground Electricity, Street Light, Electricity Pillar & NBN
- Developer Fencing
- Concrete Pathway
- Zero Setback Building Line
- Landscape Street Tree
- Indicative Building Envelope
- Bin Pads
- Indicative Parking Access Location

ADDITIONAL NOTES:

Allotments used as Multiple Residential Allotments in accordance with the approved Plan of Development may have a reduced primary road setback to 3.0metres as noted on the Plan of Development Table.

Compaction of any fill material placed on this site shall be completed to level one inspection and testing services in accordance with AS3798-2007.

Location of sewer, roofwater, stormwater, water reticulation and electricity lines, manholes and pits are those shown on engineering design drawings, supplied by Peak Urban and may differ from the as-constructed location.

Plan of Development information Supplied by RPS Group PLC.

Copyright © Veris Australia Pty Ltd
December 2024

Plot Date: 11 Dec, 2024
Computer File Ref: 30109-St4H-SP-(A).dwg



PROPOSED LOT 1628

PROPOSED LOT 1627

PROPOSED LOT 1626

PROPOSED LOT 1639

1977
375m²

PROPOSED LOT 1978

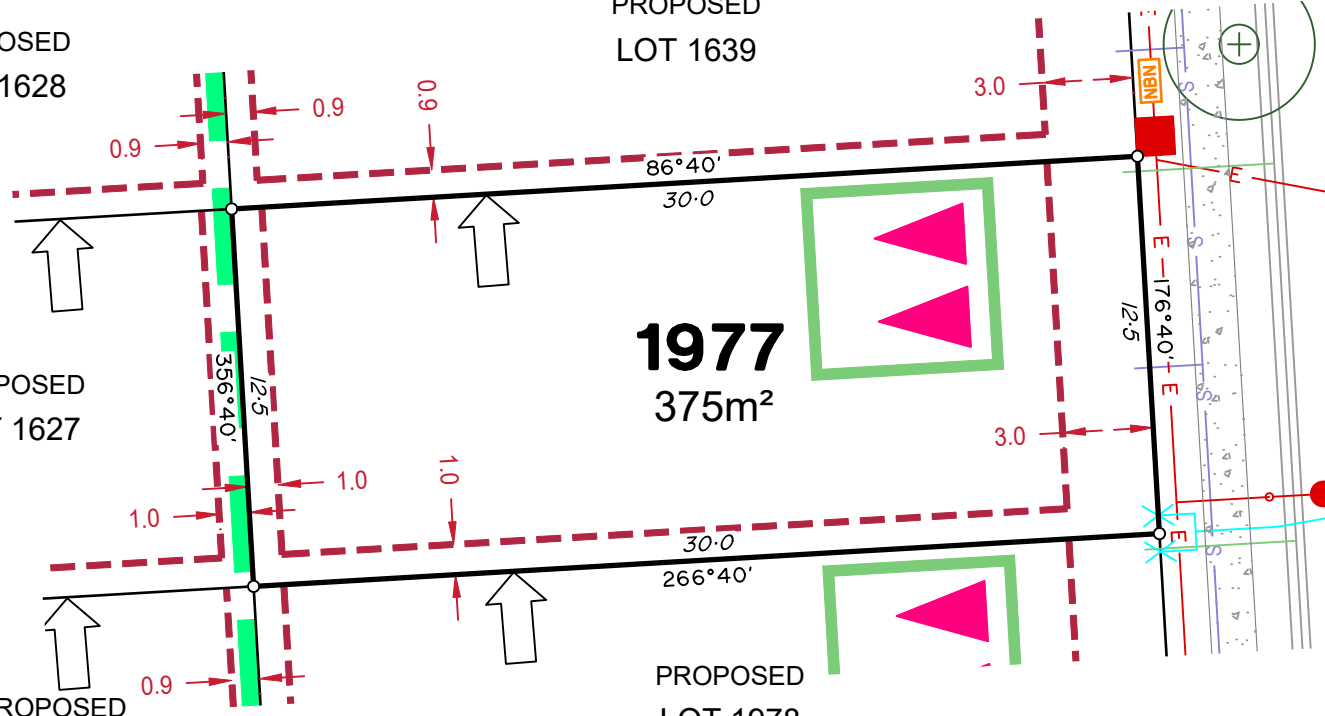

LEGEND

- Rock Retaining Wall shown as:-
- Sleeper Retaining Wall shown as:-
- Landscape Retaining Wall shown as:-
- Sewer line
- Sewer Manhole
- Roofwater Drainage line and Catch Pit
- Stormwater Drainage Line
- Stormwater Manhole
- Stormwater Pit
- Water Main
- Water Conduit
- Water Service Point of Entry
- Underground Electricity, Street Light, Electricity Pillar & NBN
- Developer Fencing
- Concrete Pathway
- Zero Setback Building Line
- Landscape Street Tree
- Indicative Building Envelope
- Bin Pads
- Indicative Parking Access Location

REALM

COURT

ADDITIONAL NOTES:

Allotments used as Multiple Residential Allotments in accordance with the approved Plan of Development may have a reduced primary road setback to 3.0metres as noted on the Plan of Development Table.

Compaction of any fill material placed on this site shall be completed to level one inspection and testing services in accordance with AS3798-2007.

Location of sewer, roofwater, stormwater, water reticulation and electricity lines, manholes and pits are those shown on engineering design drawings, supplied by Peak Urban and may differ from the as-constructed location.

Plan of Development information Supplied by RPS Group PLC.

Copyright © Veris Australia Pty Ltd
December 2024

Plot Date: 11 Dec, 2024
Computer File Ref: 30109-St4H-SP-(A).dwg

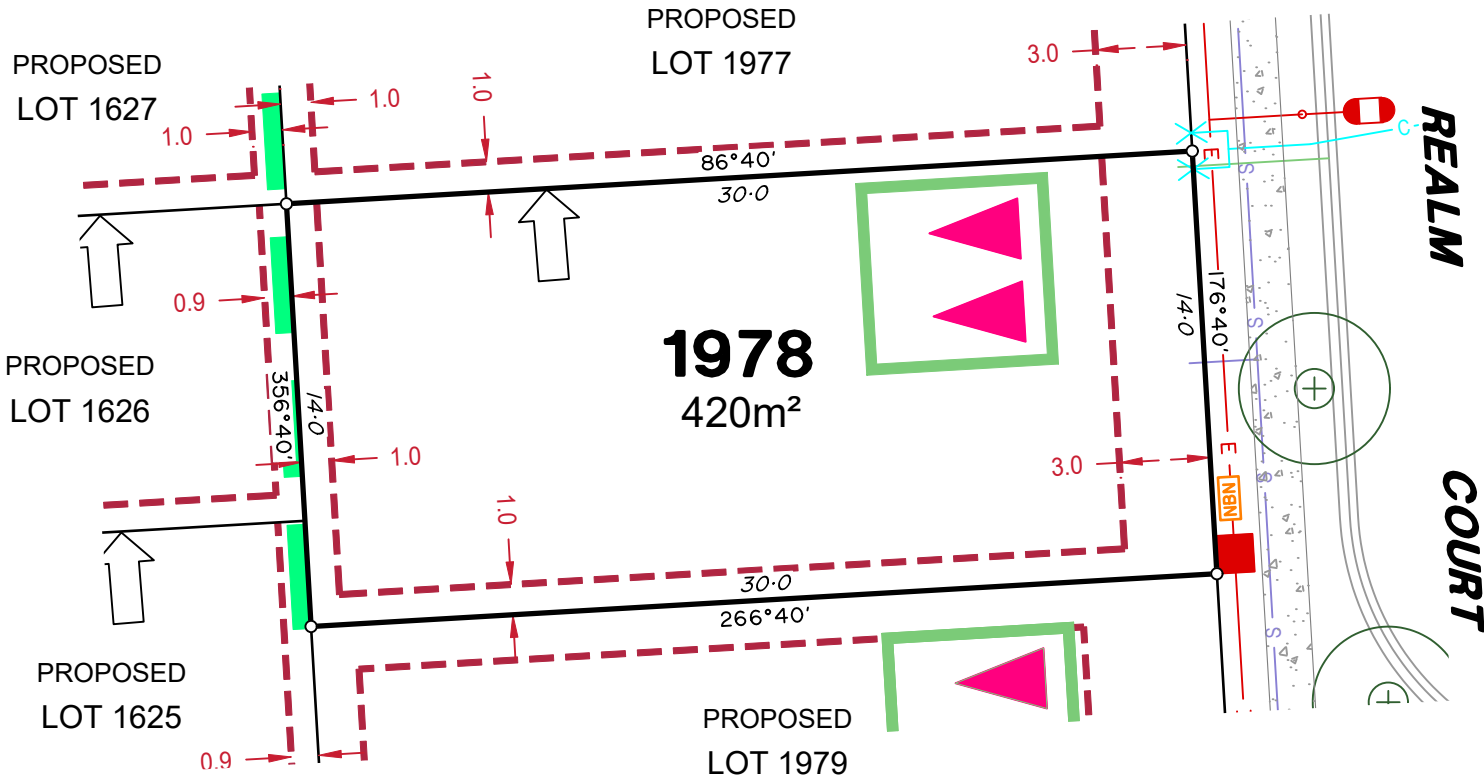

LEGEND

Rock Retaining Wall shown as:-	
Sleeper Retaining Wall shown as:-	
Landscape Retaining Wall shown as:-	
Sewer line	
Sewer Manhole	
Roofwater Drainage line and Catch Pit	
Stormwater Drainage Line	
Stormwater Manhole	
Stormwater Pit	
Water Main	
Water Conduit	
Water Service Point of Entry	
Underground Electricity, Street Light, Electricity Pillar & NBN	
Developer Fencing	
Concrete Pathway	
Zero Setback Building Line	
Indicative Building Envelope	
Bin Pads	
Indicative Parking Access Location	
Landscape Street Tree	

ADDITIONAL NOTES:

Allotments used as Multiple Residential Allotments in accordance with the approved Plan of Development may have a reduced primary road setback to 3.0metres as noted on the Plan of Development Table.

Compaction of any fill material placed on this site shall be completed to level one inspection and testing services in accordance with AS3798-2007.

Location of sewer, roofwater, stormwater, water reticulation and electricity lines, manholes and pits are those shown on engineering design drawings, supplied by Peak Urban and may differ from the as-constructed location.

Plan of Development information Supplied by RPS Group PLC.

Copyright © Veris Australia Pty Ltd
December 2024

Plot Date: 11 Dec, 2024
Computer File Ref: 30109-St4H-SP-(A).dwg

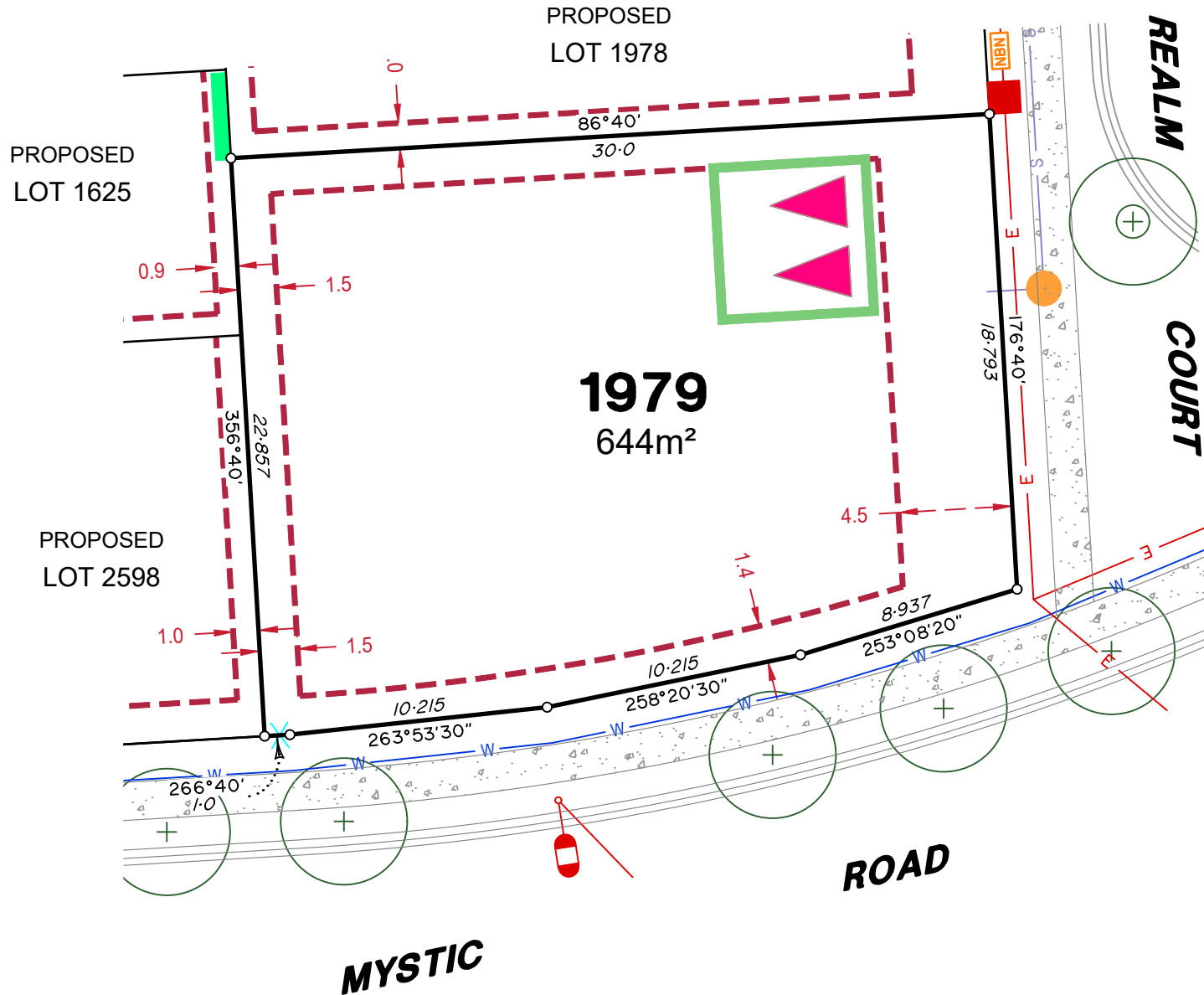

LEGEND

Rock Retaining Wall shown as:-	
Sleeper Retaining Wall shown as:-	
Landscape Retaining Wall shown as:-	
Sewer line	
Sewer Manhole	
Roofwater Drainage line and Catch Pit	
Stormwater Drainage Line	
Stormwater Manhole	
Stormwater Pit	
Water Main	
Water Conduit	
Water Service Point of Entry	
Underground Electricity, Street Light, Electricity Pillar & NBN	
Developer Fencing	
Concrete Pathway	
Zero Setback Building Line	
Indicative Building Envelope	
Bin Pads	
Indicative Parking Access Location	
Landscape Street Tree	

ADDITIONAL NOTES:

Allotments used as Multiple Residential Allotments in accordance with the approved Plan of Development may have a reduced primary road setback to 3.0metres as noted on the Plan of Development Table.

Compaction of any fill material placed on this site shall be completed to level one inspection and testing services in accordance with AS3798-2007.

Location of sewer, roofwater, stormwater, water reticulation and electricity lines, manholes and pits are those shown on engineering design drawings, supplied by Peak Urban and may differ from the as-constructed location.

Plan of Development information Supplied by RPS Group PLC.

Copyright © Veris Australia Pty Ltd
December 2024

Plot Date: 11 Dec, 2024
Computer File Ref: 30109-St4H-SP-(A).dwg

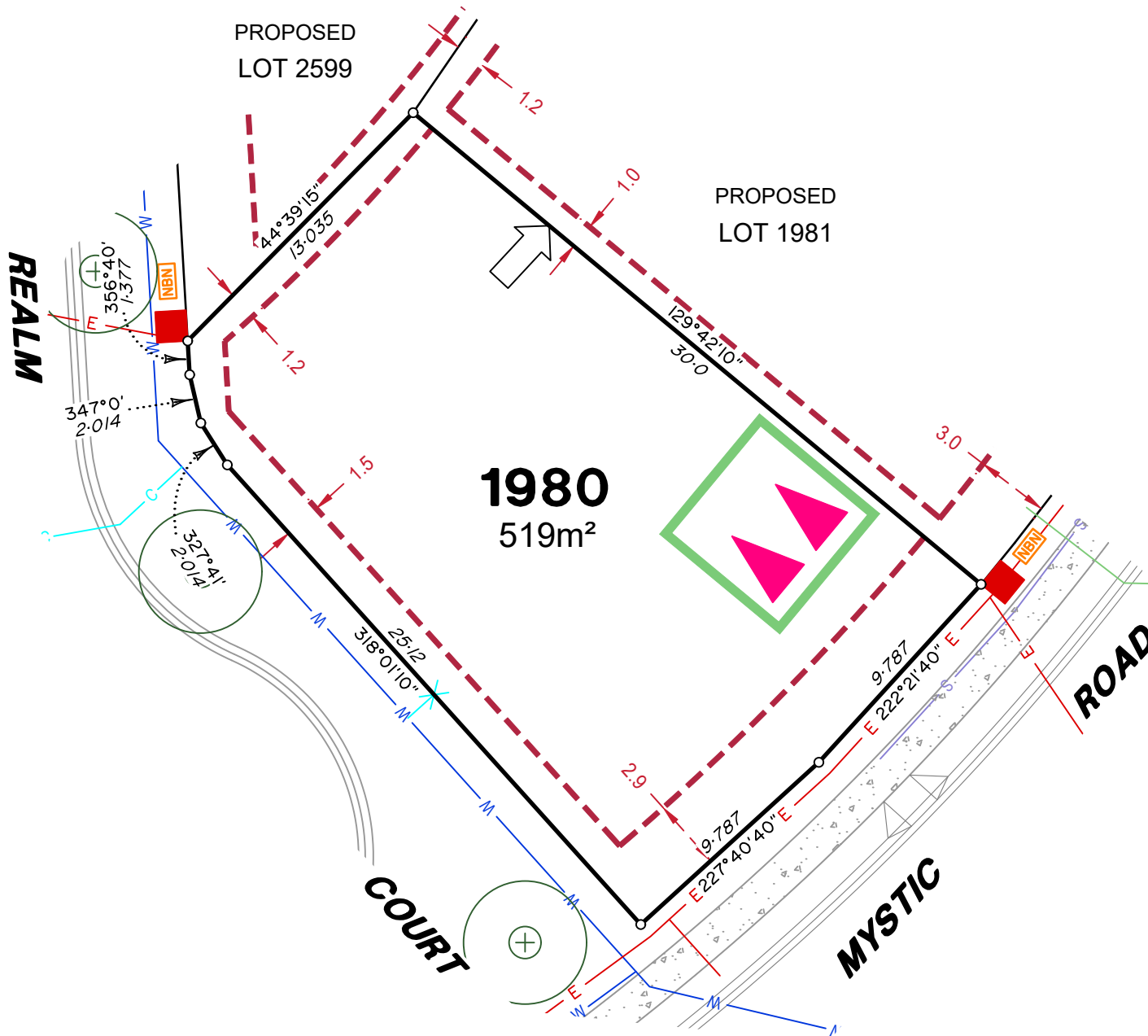

LEGEND

Rock Retaining Wall shown as:-		
Sleeper Retaining Wall shown as:-		
Landscape Retaining Wall shown as:-		
Sewer line		
Sewer Manhole		
Roofwater Drainage line and Catch Pit		
Stormwater Drainage Line		
Stormwater Manhole		
Stormwater Pit		
Water Main		
Water Conduit		
Water Service Point of Entry		
Underground Electricity, Street Light, Electricity Pillar & NBN		
Developer Fencing		
Concrete Pathway		Landscape Street Tree
Zero Setback Building Line		Indicative Building Envelope
	Bin Pads	
	Indicative Parking Access Location	

ADDITIONAL NOTES:

Allotments used as Multiple Residential Allotments in accordance with the approved Plan of Development may have a reduced primary road setback to 3.0metres as noted on the Plan of Development Table.

Compaction of any fill material placed on this site shall be completed to level one inspection and testing services in accordance with AS3798-2007.

Location of sewer, roofwater, stormwater, water reticulation and electricity lines, manholes and pits are those shown on engineering design drawings, supplied by Peak Urban and may differ from the as-constructed location.

Plan of Development information Supplied by RPS Group PLC.

Copyright © Veris Australia Pty Ltd
December 2024

Plot Date: 11 Dec, 2024
Computer File Ref: 30109-St4H-SP-(A).dwg

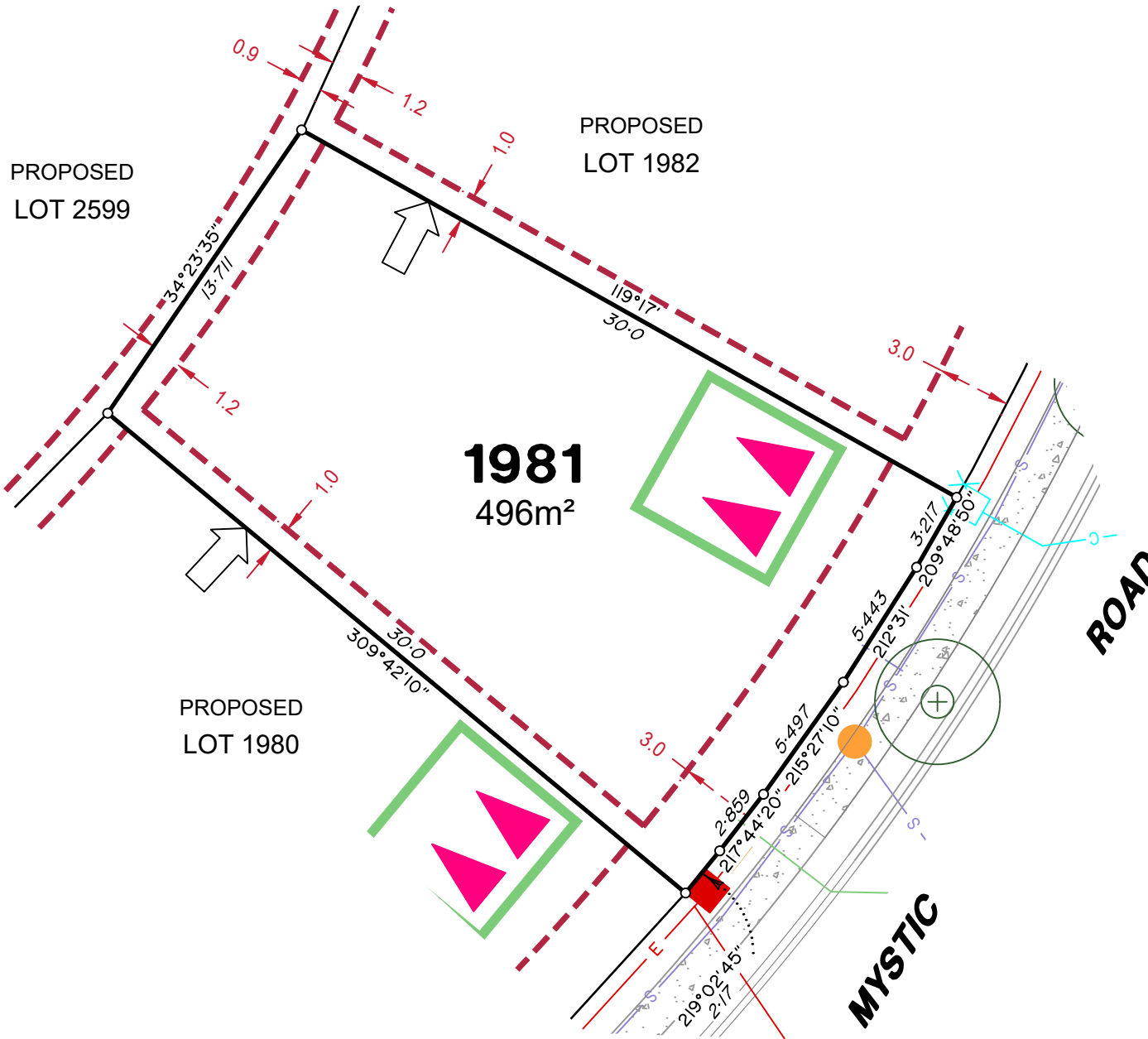

LEGEND

Rock Retaining Wall shown as:-	
Sleeper Retaining Wall shown as:-	
Landscape Retaining Wall shown as:-	
Sewer line	
Sewer Manhole	
Roofwater Drainage line and Catch Pit	
Stormwater Drainage Line	
Stormwater Manhole	
Stormwater Pit	
Water Main	
Water Conduit	
Water Service Point of Entry	
Underground Electricity, Street Light, Electricity Pillar & NBN	
Developer Fencing	
Concrete Pathway	
Zero Setback Building Line	
Landscape Street Tree	
Indicative Building Envelope	
Bin Pads	
Indicative Parking Access Location	

ADDITIONAL NOTES:

Allotments used as Multiple Residential Allotments in accordance with the approved Plan of Development may have a reduced primary road setback to 3.0metres as noted on the Plan of Development Table.

Compaction of any fill material placed on this site shall be completed to level one inspection and testing services in accordance with AS3798-2007.

Location of sewer, roofwater, stormwater, water reticulation and electricity lines, manholes and pits are those shown on engineering design drawings, supplied by Peak Urban and may differ from the as-constructed location.

Plan of Development information Supplied by RPS Group PLC.

Copyright © Veris Australia Pty Ltd
December 2024

Plot Date: 11 Dec, 2024
Computer File Ref: 30109-St4H-SP-(A).dwg

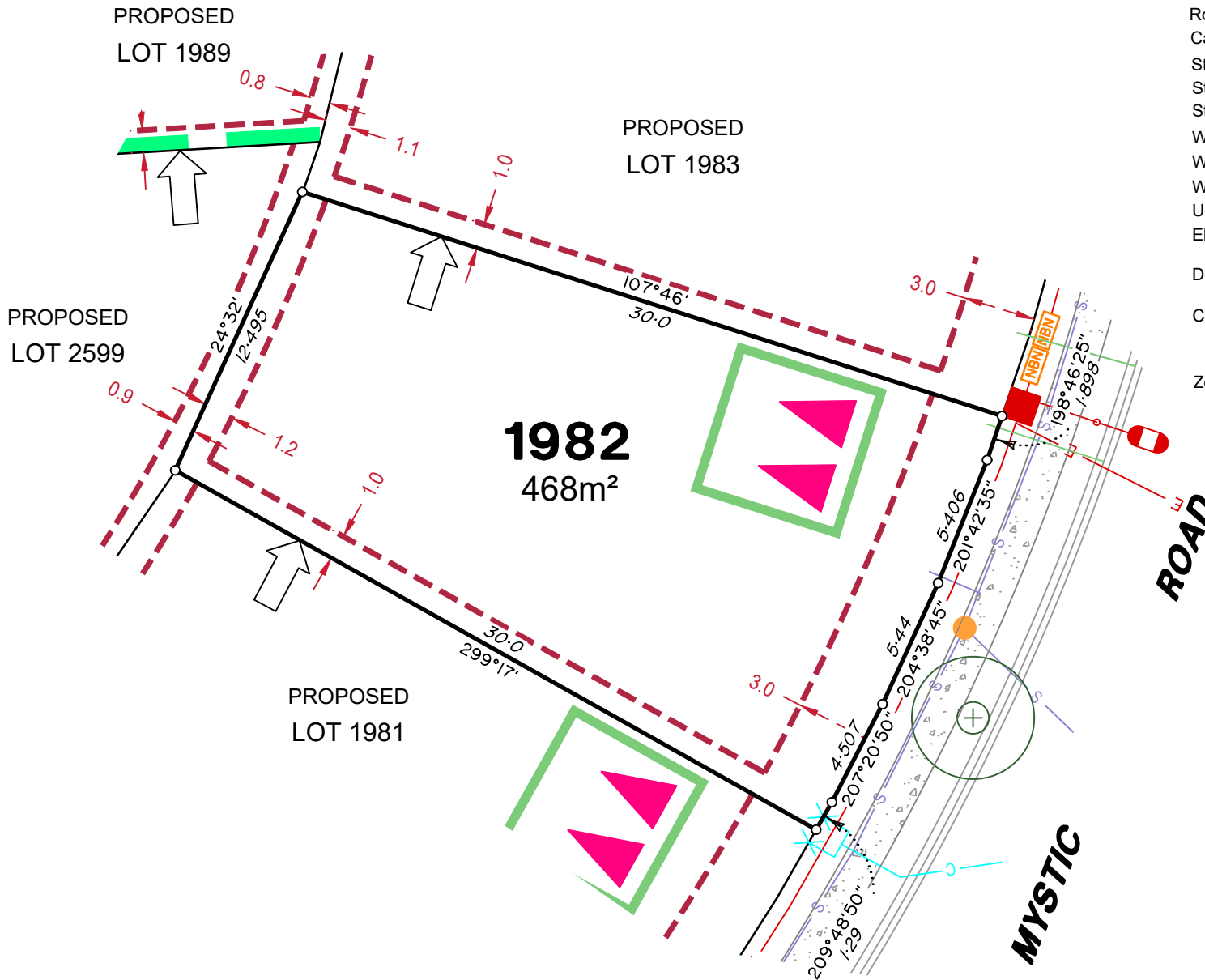

LEGEND

Rock Retaining Wall shown as:-	
Sleeper Retaining Wall shown as:-	
Landscape Retaining Wall shown as:-	
Sewer line	
Sewer Manhole	
Roofwater Drainage line and Catch Pit	
Stormwater Drainage Line	
Stormwater Manhole	
Stormwater Pit	
Water Main	
Water Conduit	
Water Service Point of Entry	
Underground Electricity, Street Light, Electricity Pillar & NBN	
Developer Fencing	
Concrete Pathway	
Zero Setback Building Line	
Landscape Street Tree	
Indicative Building Envelope	
Bin Pads	
Indicative Parking Access Location	

ADDITIONAL NOTES:

Allotments used as Multiple Residential Allotments in accordance with the approved Plan of Development may have a reduced primary road setback to 3.0metres as noted on the Plan of Development Table.

Compaction of any fill material placed on this site shall be completed to level one inspection and testing services in accordance with AS3798-2007.

Location of sewer, roofwater, stormwater, water reticulation and electricity lines, manholes and pits are those shown on engineering design drawings, supplied by Peak Urban and may differ from the as-constructed location.

Plan of Development information Supplied by RPS Group PLC.

Copyright © Veris Australia Pty Ltd
December 2024

Plot Date: 11 Dec, 2024
Computer File Ref: 30109-St4H-SP-(A).dwg



LEGEND

Rock Retaining Wall shown as:-	
Sleeper Retaining Wall shown as:-	
Landscape Retaining Wall shown as:-	
Sewer line	
Sewer Manhole	
Roofwater Drainage line and Catch Pit	
Stormwater Drainage Line	
Stormwater Manhole	
Stormwater Pit	
Water Main	
Water Conduit	
Water Service Point of Entry	
Underground Electricity, Street Light, Electricity Pillar & NBN	
Developer Fencing	
Concrete Pathway	
Zero Setback Building Line	
Landscape Street Tree	
Indicative Building Envelope	
Bin Pads	
Indicative Parking Access Location	

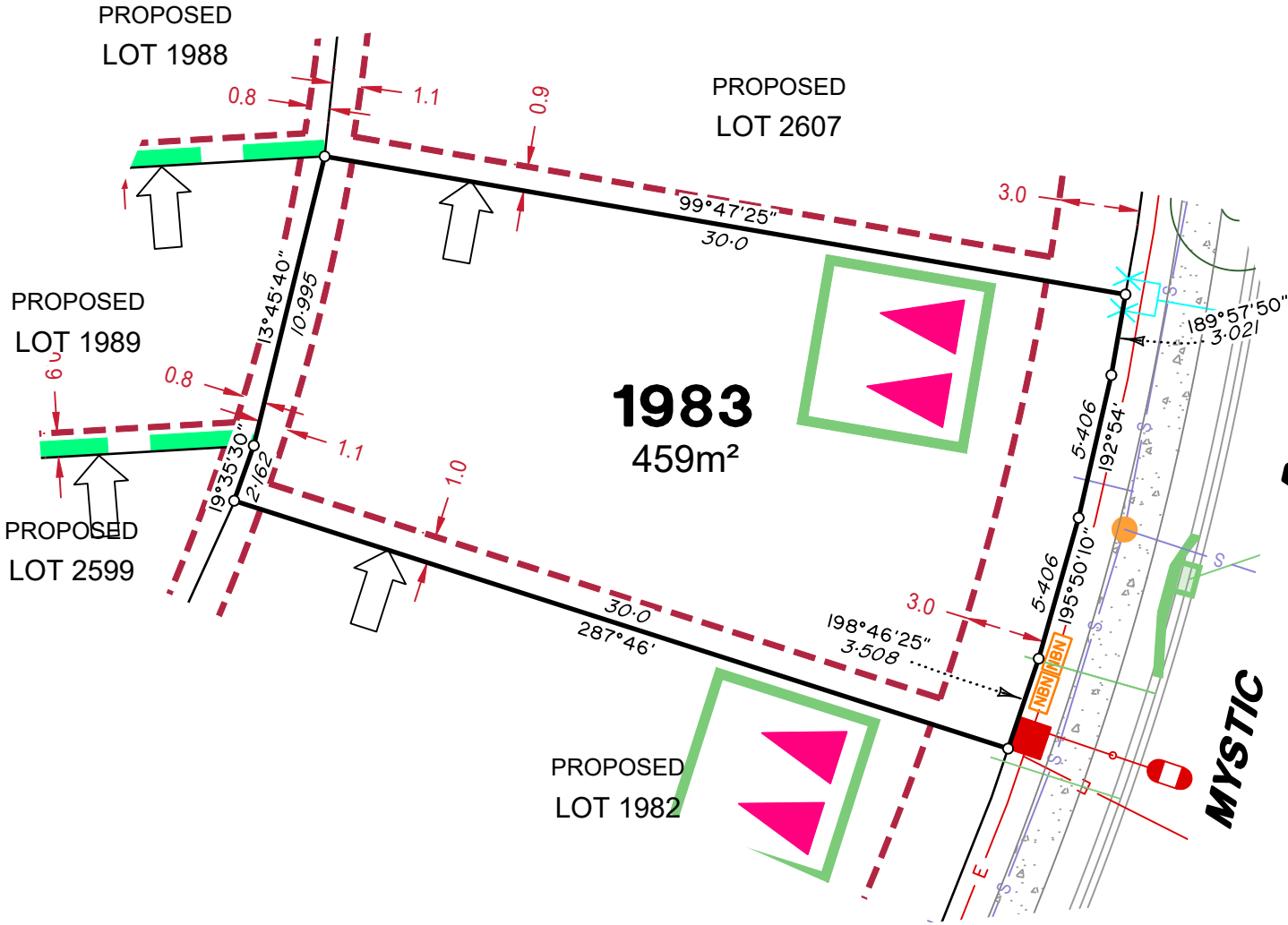

MYSTIC ROAD

ADDITIONAL NOTES:

Allotments used as Multiple Residential Allotments in accordance with the approved Plan of Development may have a reduced primary road setback to 3.0metres as noted on the Plan of Development Table.

Compaction of any fill material placed on this site shall be completed to level one inspection and testing services in accordance with AS3798-2007.

Location of sewer, roofwater, stormwater, water reticulation and electricity lines, manholes and pits are those shown on engineering design drawings, supplied by Peak Urban and may differ from the as-constructed location.

Plan of Development information Supplied by RPS Group PLC.

Copyright © Veris Australia Pty Ltd
December 2024

Plot Date: 11 Dec, 2024
 Computer File Ref: 30109-St4H-SP-(A).dwg

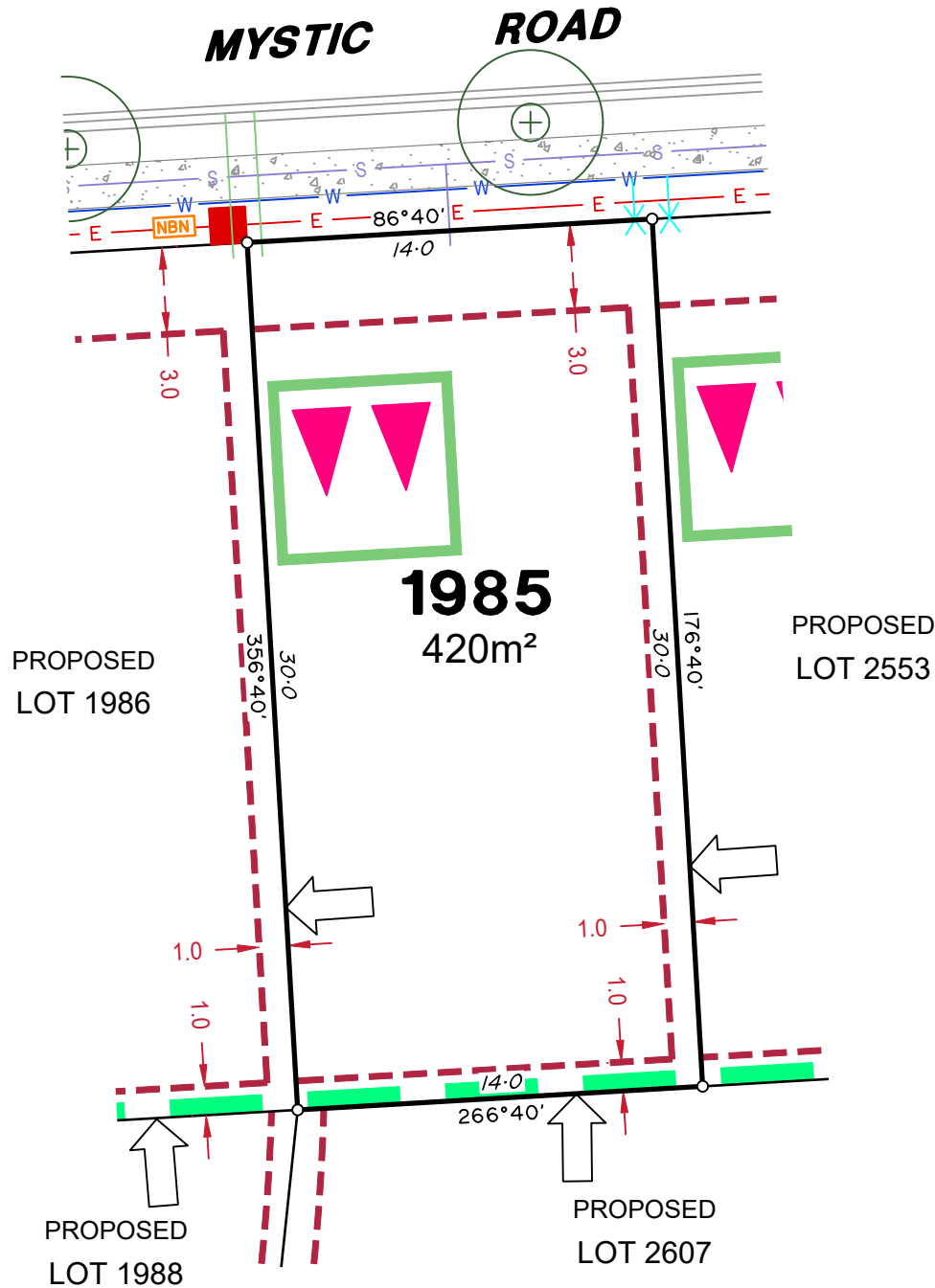

LEGEND

Rock Retaining Wall shown as:-	
Sleeper Retaining Wall shown as:-	
Landscape Retaining Wall shown as:-	
Sewer line	
Sewer Manhole	
Roofwater Drainage line and Catch Pit	
Stormwater Drainage Line	
Stormwater Manhole	
Stormwater Pit	
Water Main	
Water Conduit	
Water Service Point of Entry	
Underground Electricity, Street Light, Electricity Pillar & NBN	
Developer Fencing	
Concrete Pathway	
Landscape Street Tree	
Zero Setback Building Line	
Indicative Building Envelope	
Bin Pads	
Indicative Parking Access Location	

ADDITIONAL NOTES:

Allotments used as Multiple Residential Allotments in accordance with the approved Plan of Development may have a reduced primary road setback to 3.0metres as noted on the Plan of Development Table.

Compaction of any fill material placed on this site shall be completed to level one inspection and testing services in accordance with AS3798-2007.

Location of sewer, roofwater, stormwater, water reticulation and electricity lines, manholes and pits are those shown on engineering design drawings, supplied by Peak Urban and may differ from the as-constructed location.

Plan of Development information Supplied by RPS Group PLC.

Copyright © Veris Australia Pty Ltd
December 2024

Plot Date: 11 Dec, 2024
Computer File Ref: 30109-St4H-SP-(A).dwg

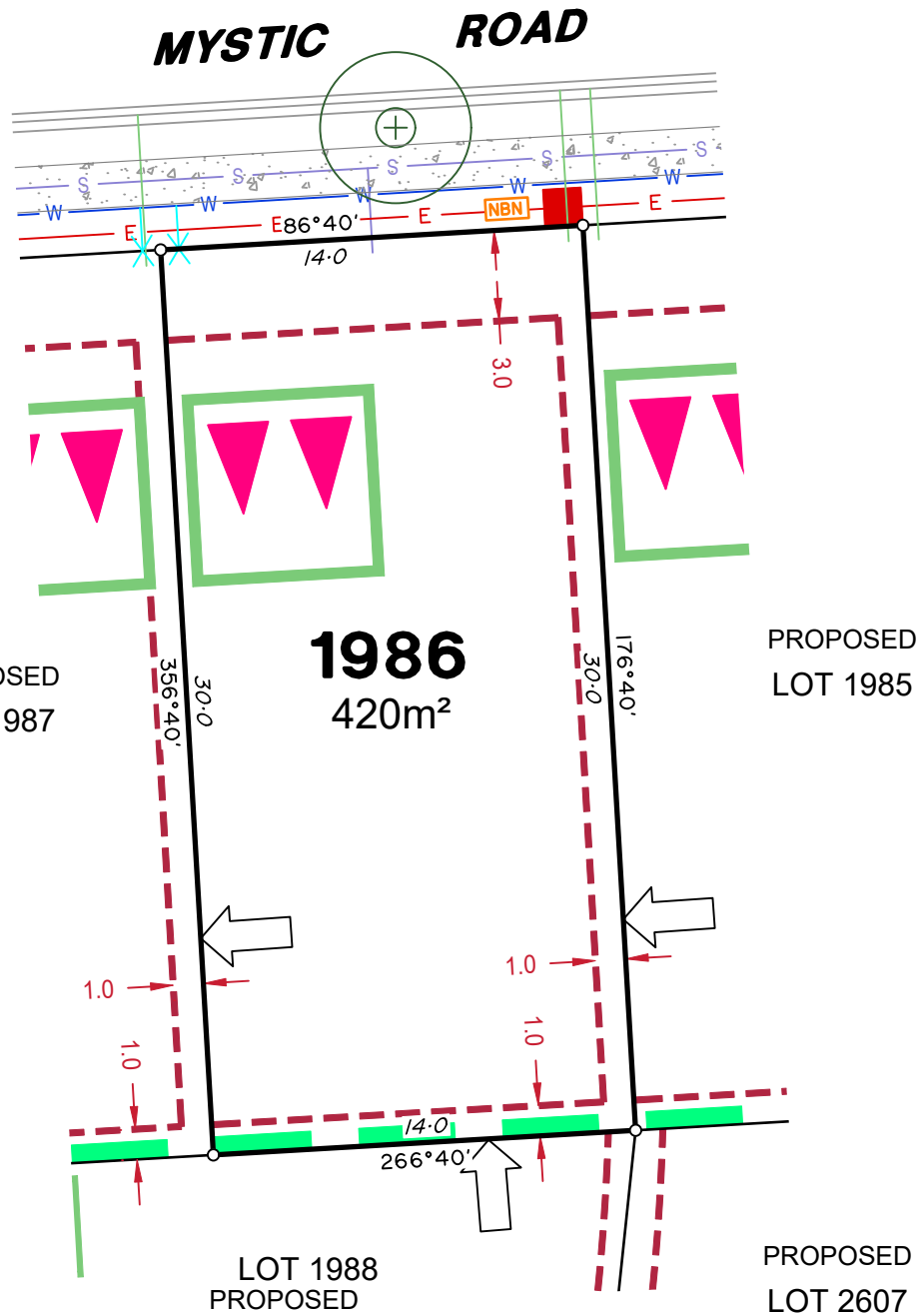

LEGEND

Rock Retaining Wall shown as:-	
Sleeper Retaining Wall shown as:-	
Landscape Retaining Wall shown as:-	
Sewer line	
Sewer Manhole	
Roofwater Drainage line and Catch Pit	
Stormwater Drainage Line	
Stormwater Manhole	
Stormwater Pit	
Water Main	
Water Conduit	
Water Service Point of Entry	
Underground Electricity, Street Light, Electricity Pillar & NBN	
Developer Fencing	
Concrete Pathway	
Zero Setback Building Line	
Landscape Street Tree	
Indicative Building Envelope	
Bin Pads	
Indicative Parking Access Location	

ADDITIONAL NOTES:

Allotments used as Multiple Residential Allotments in accordance with the approved Plan of Development may have a reduced primary road setback to 3.0metres as noted on the Plan of Development Table.

Compaction of any fill material placed on this site shall be completed to level one inspection and testing services in accordance with AS3798-2007.

Location of sewer, roofwater, stormwater, water reticulation and electricity lines, manholes and pits are those shown on engineering design drawings, supplied by Peak Urban and may differ from the as-constructed location.

Plan of Development information Supplied by RPS Group PLC.

Copyright © Veris Australia Pty Ltd
December 2024

Plot Date: 11 Dec, 2024
Computer File Ref: 30109-St4H-SP-(A).dwg

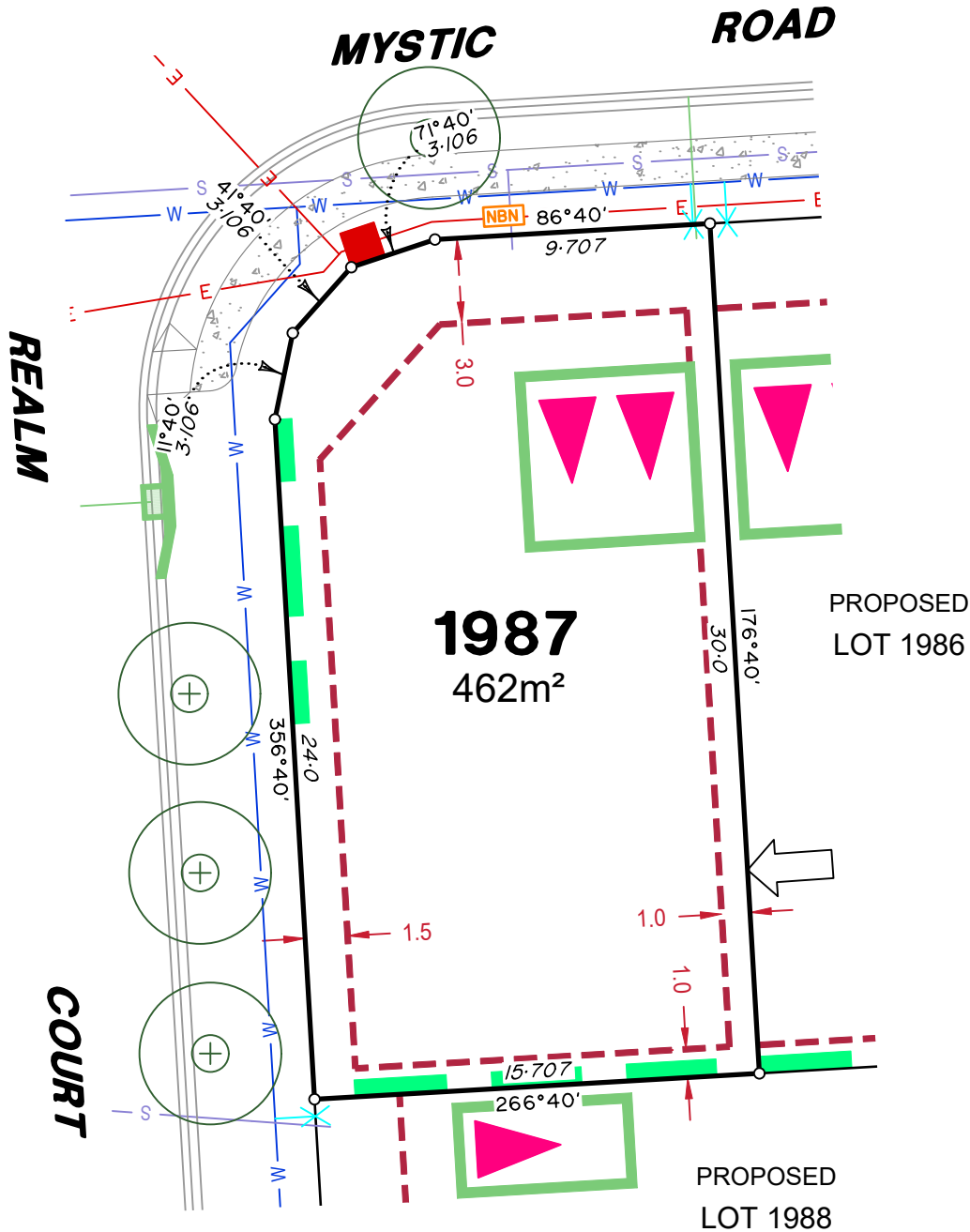

LEGEND

Rock Retaining Wall shown as:-	
Sleeper Retaining Wall shown as:-	
Landscape Retaining Wall shown as:-	
Sewer line	
Sewer Manhole	
Roofwater Drainage line and Catch Pit	
Stormwater Drainage Line	
Stormwater Manhole	
Stormwater Pit	
Water Main	
Water Conduit	
Water Service Point of Entry	
Underground Electricity, Street Light, Electricity Pillar & NBN	
Developer Fencing	
Concrete Pathway	
Landscape Street Tree	
Zero Setback Building Line	
Indicative Building Envelope	
Bin Pads	
Indicative Parking Access Location	

ADDITIONAL NOTES:

Allotments used as Multiple Residential Allotments in accordance with the approved Plan of Development may have a reduced primary road setback to 3.0metres as noted on the Plan of Development Table.

Compaction of any fill material placed on this site shall be completed to level one inspection and testing services in accordance with AS3798-2007.

Location of sewer, roofwater, stormwater, water reticulation and electricity lines, manholes and pits are those shown on engineering design drawings, supplied by Peak Urban and may differ from the as-constructed location.

Plan of Development information Supplied by RPS Group PLC.

Copyright © Veris Australia Pty Ltd
December 2024

Plot Date: 11 Dec, 2024
Computer File Ref: 30109-S4H-SP-(A).dwg

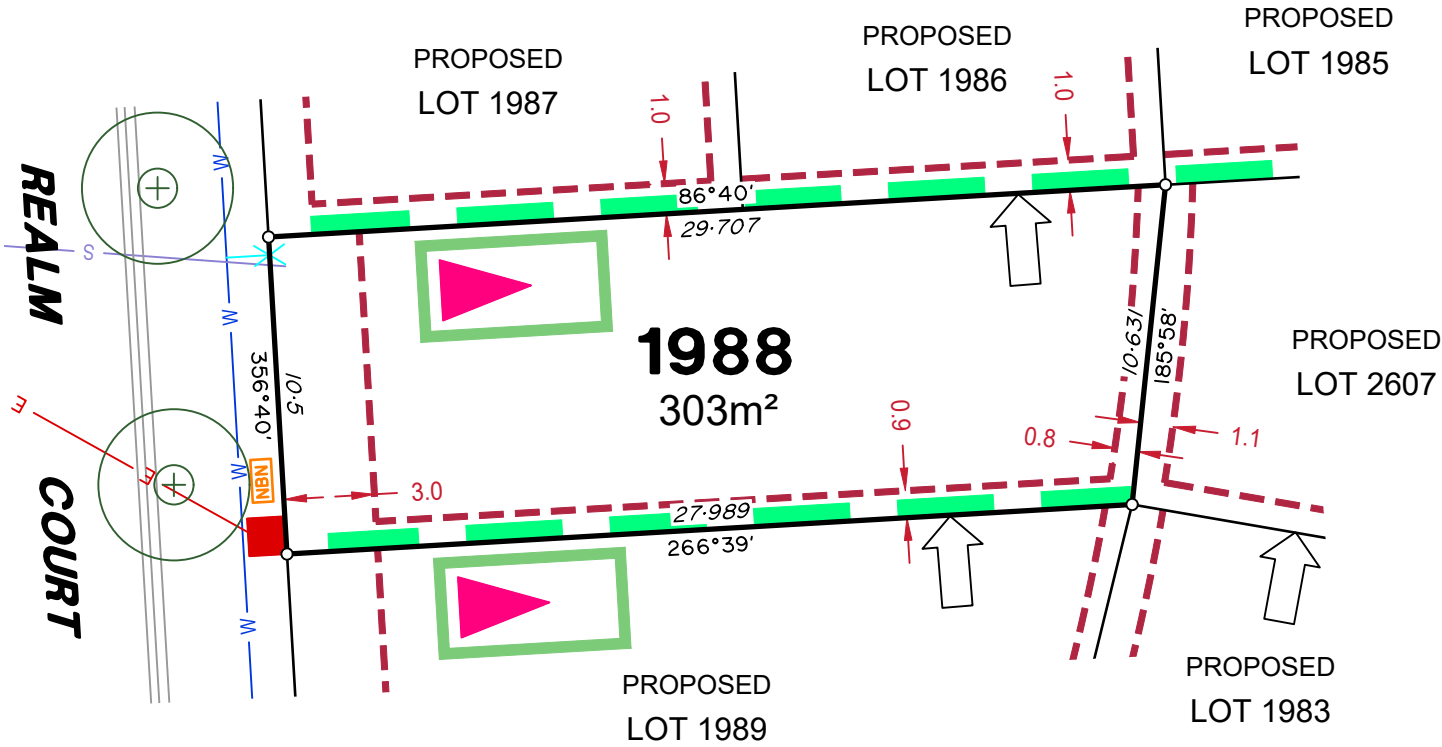

LEGEND

Rock Retaining Wall shown as:-	
Sleeper Retaining Wall shown as:-	
Landscape Retaining Wall shown as:-	
Sewer line	
Sewer Manhole	
Roofwater Drainage line and Catch Pit	
Stormwater Drainage Line	
Stormwater Manhole	
Stormwater Pit	
Water Main	
Water Conduit	
Water Service Point of Entry	
Underground Electricity, Street Light, Electricity Pillar & NBN	
Developer Fencing	
Concrete Pathway	
Landscape Street Tree	
Zero Setback Building Line	
Indicative Building Envelope	
Bin Pads	
Indicative Parking Access Location	

ADDITIONAL NOTES:

Allotments used as Multiple Residential Allotments in accordance with the approved Plan of Development may have a reduced primary road setback to 3.0metres as noted on the Plan of Development Table.

Compaction of any fill material placed on this site shall be completed to level one inspection and testing services in accordance with AS3798-2007.

Location of sewer, roofwater, stormwater, water reticulation and electricity lines, manholes and pits are those shown on engineering design drawings, supplied by Peak Urban and may differ from the as-constructed location.

Plan of Development information Supplied by RPS Group PLC.

Copyright © Veris Australia Pty Ltd
December 2024

Plot Date: 11 Dec, 2024
Computer File Ref: 30109-St4H-SP-(A).dwg



REALM
COURT

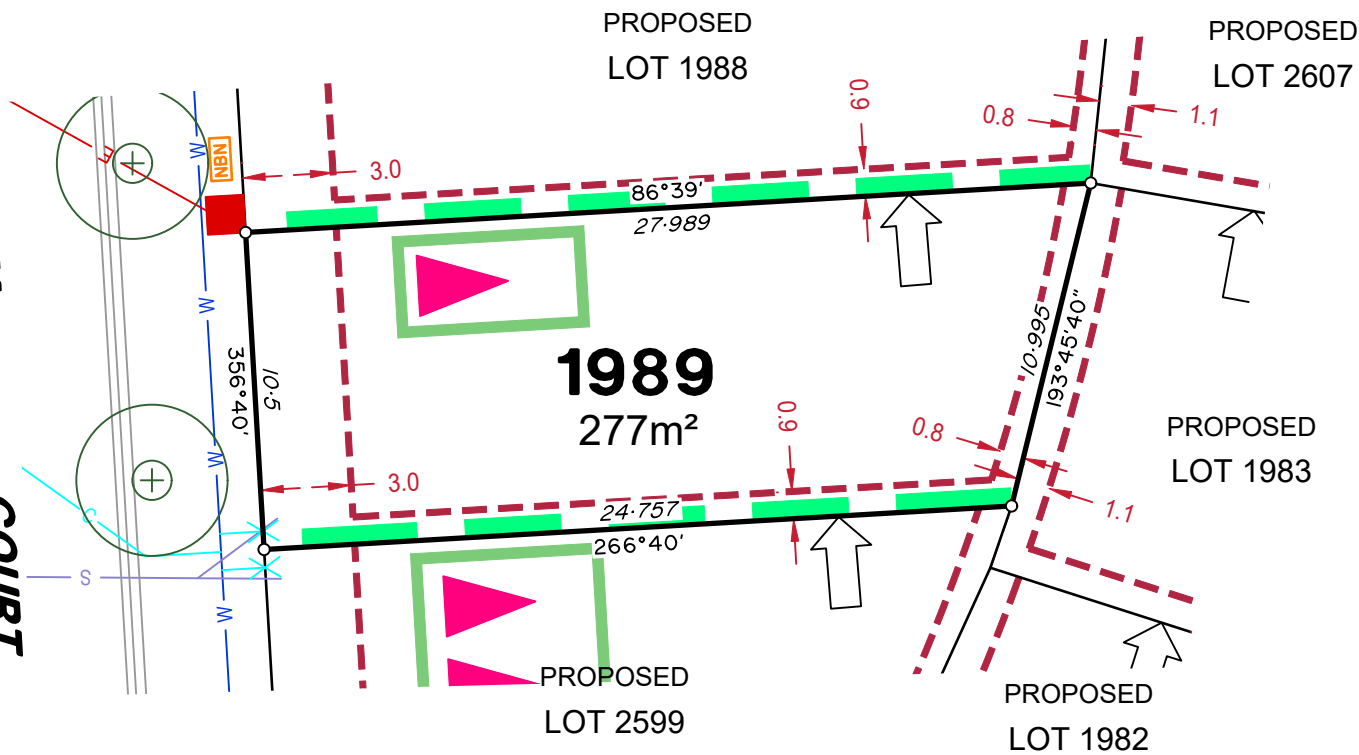

LEGEND

Rock Retaining Wall shown as:-	
Sleeper Retaining Wall shown as:-	
Landscape Retaining Wall shown as:-	
Sewer line	
Sewer Manhole	
Roofwater Drainage line and Catch Pit	
Stormwater Drainage Line	
Stormwater Manhole	
Stormwater Pit	
Water Main	
Water Conduit	
Water Service Point of Entry	
Underground Electricity, Street Light, Electricity Pillar & NBN	
Developer Fencing	
Concrete Pathway	
Landscaping Street Tree	
Zero Setback Building Line	
Indicative Building Envelope	
Bin Pads	
Indicative Parking Access Location	

ADDITIONAL NOTES:

Allotments used as Multiple Residential Allotments in accordance with the approved Plan of Development may have a reduced primary road setback to 3.0metres as noted on the Plan of Development Table.

Compaction of any fill material placed on this site shall be completed to level one inspection and testing services in accordance with AS3798-2007.

Location of sewer, roofwater, stormwater, water reticulation and electricity lines, manholes and pits are those shown on engineering design drawings, supplied by Peak Urban and may differ from the as-constructed location.

Plan of Development information Supplied by RPS Group PLC.

Copyright © Veris Australia Pty Ltd
December 2024

Plot Date: 11 Dec, 2024
Computer File Ref: 30109-St4H-SP-(A).dwg



MYSTIC ROAD

MYSTIC ROAD

ROAD

PROPOSED LOT 1985

2553
479m²

PROPOSED LOT 1984

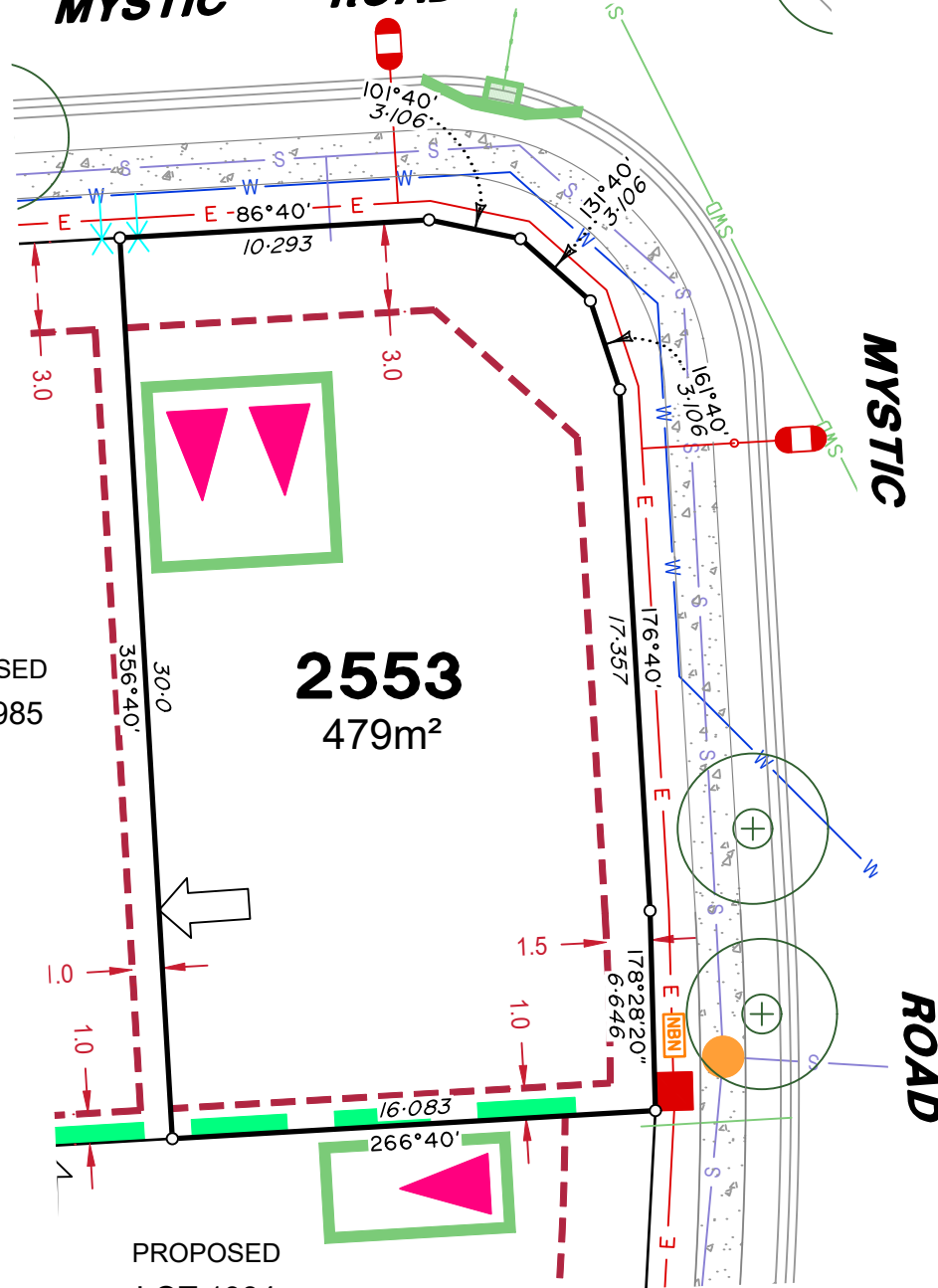

LEGEND

Rock Retaining Wall shown as:-	
Sleeper Retaining Wall shown as:-	
Landscape Retaining Wall shown as:-	
Sewer line	
Sewer Manhole	
Roofwater Drainage line and Catch Pit	
Stormwater Drainage Line	
Stormwater Manhole	
Stormwater Pit	
Water Main	
Water Conduit	
Water Service Point of Entry	
Underground Electricity, Street Light, Electricity Pillar & NBN	
Developer Fencing	
Concrete Pathway	
Zero Setback Building Line	
Indicative Building Envelope	
Bin Pads	
Indicative Parking Access Location	
Landscape Street Tree	

ADDITIONAL NOTES:

Allotments used as Multiple Residential Allotments in accordance with the approved Plan of Development may have a reduced primary road setback to 3.0metres as noted on the Plan of Development Table.

Compaction of any fill material placed on this site shall be completed to level one inspection and testing services in accordance with AS3798-2007.

Location of sewer, roofwater, stormwater, water reticulation and electricity lines, manholes and pits are those shown on engineering design drawings, supplied by Peak Urban and may differ from the as-constructed location.

Plan of Development information Supplied by RPS Group PLC.

Copyright © Veris Australia Pty Ltd
December 2024

Plot Date: 11 Dec, 2024
Computer File Ref: 30109-S14H-SP-(A).dwg

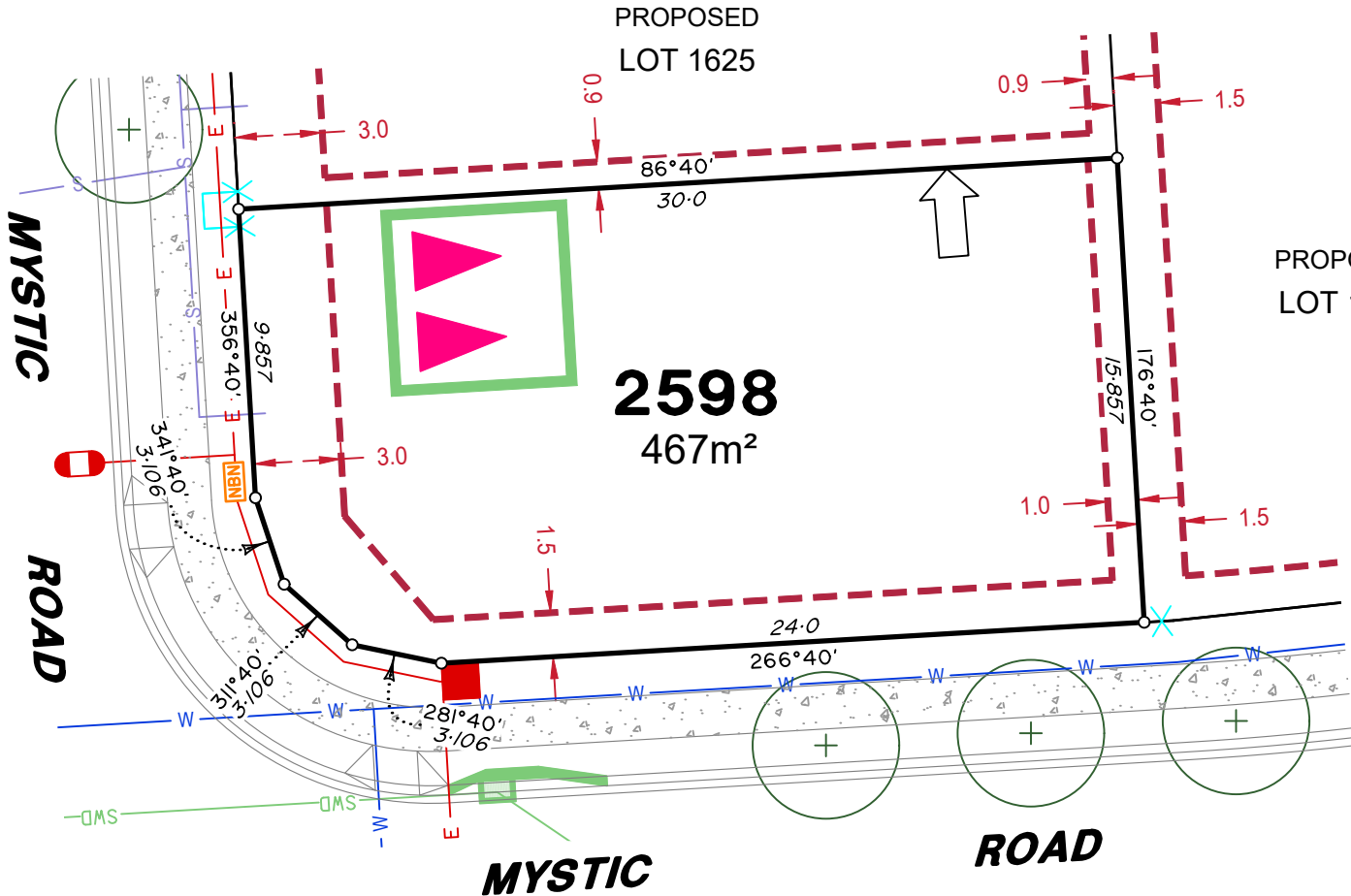

LEGEND

Rock Retaining Wall shown as:-	
Sleeper Retaining Wall shown as:-	
Landscape Retaining Wall shown as:-	
Sewer line	
Sewer Manhole	
Roofwater Drainage line and Catch Pit	
Stormwater Drainage Line	
Stormwater Manhole	
Stormwater Pit	
Water Main	
Water Conduit	
Water Service Point of Entry	
Underground Electricity, Street Light, Electricity Pillar & NBN	
Developer Fencing	
Concrete Pathway	
Zero Setback Building Line	
Landscape Street Tree	
Indicative Building Envelope	
Bin Pads	
Indicative Parking Access Location	

ADDITIONAL NOTES:

Allotments used as Multiple Residential Allotments in accordance with the approved Plan of Development may have a reduced primary road setback to 3.0metres as noted on the Plan of Development Table.

Compaction of any fill material placed on this site shall be completed to level one inspection and testing services in accordance with AS3798-2007.

Location of sewer, roofwater, stormwater, water reticulation and electricity lines, manholes and pits are those shown on engineering design drawings, supplied by Peak Urban and may differ from the as-constructed location.

Plan of Development information Supplied by RPS Group PLC.

Copyright © Veris Australia Pty Ltd
December 2024

Plot Date: 11 Dec, 2024
Computer File Ref: 30109-St4H-SP-(A).dwg

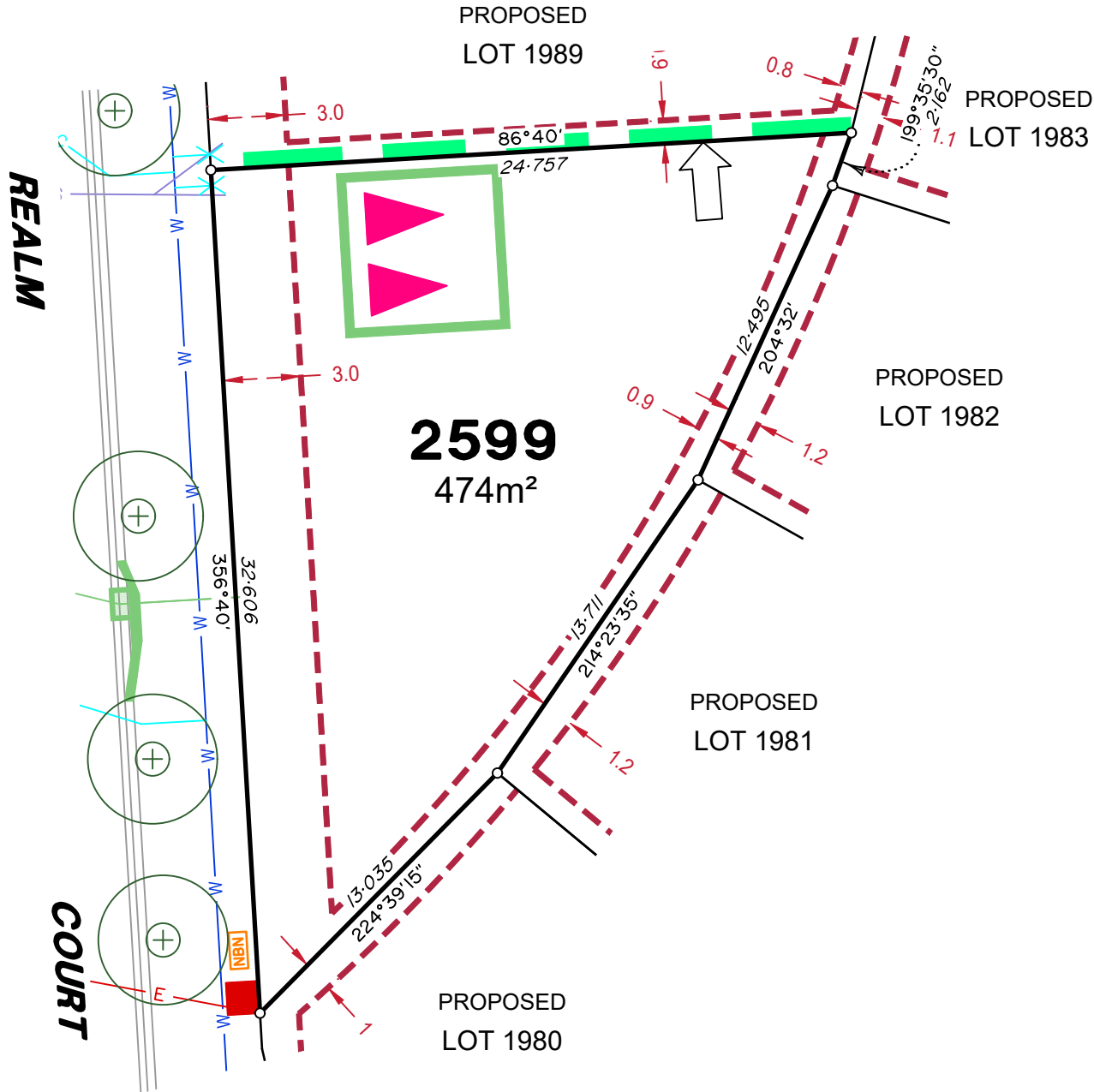

LEGEND

Rock Retaining Wall shown as:-	
Sleeper Retaining Wall shown as:-	
Landscape Retaining Wall shown as:-	
Sewer line	
Sewer Manhole	
Roofwater Drainage line and Catch Pit	
Stormwater Drainage Line	
Stormwater Manhole	
Stormwater Pit	
Water Main	
Water Conduit	
Water Service Point of Entry	
Underground Electricity, Street Light, Electricity Pillar & NBN	
Developer Fencing	
Concrete Pathway	
Zero Setback Building Line	
Landscape Street Tree	
Indicative Building Envelope	
Bin Pads	
Indicative Parking Access Location	

ADDITIONAL NOTES:

Allotments used as Multiple Residential Allotments in accordance with the approved Plan of Development may have a reduced primary road setback to 3.0metres as noted on the Plan of Development Table.

Compaction of any fill material placed on this site shall be completed to level one inspection and testing services in accordance with AS3798-2007.

Location of sewer, roofwater, stormwater, water reticulation and electricity lines, manholes and pits are those shown on engineering design drawings, supplied by Peak Urban and may differ from the as-constructed location.

Plan of Development information Supplied by RPS Group PLC.

Copyright © Veris Australia Pty Ltd
December 2024

Plot Date: 11 Dec, 2024
Computer File Ref: 30109-St4H-SP-(A).dwg

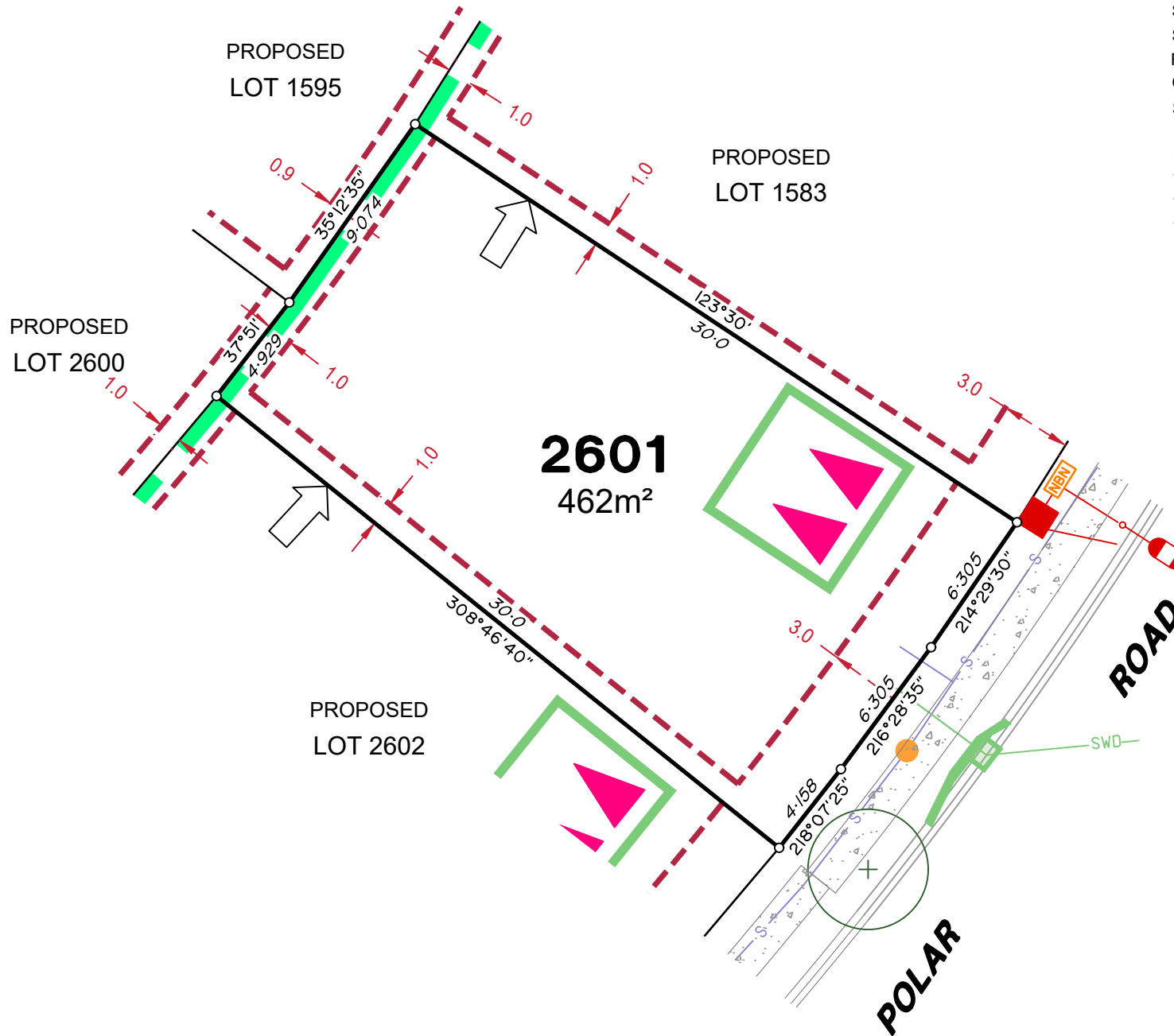

LEGEND

Rock Retaining Wall shown as:-		
Sleeper Retaining Wall shown as:-		
Landscape Retaining Wall shown as:-		
Sewer line		
Sewer Manhole		
Roofwater Drainage line and Catch Pit		
Stormwater Drainage Line		
Stormwater Manhole		
Stormwater Pit		
Water Main		
Water Conduit		
Water Service Point of Entry		
Underground Electricity, Street Light, Electricity Pillar & NBN		
Developer Fencing		
Concrete Pathway		Landscape Street Tree
Zero Setback Building Line		Indicative Building Envelope
	Bin Pads	
	Indicative Parking Access Location	

ADDITIONAL NOTES:

Allotments used as Multiple Residential Allotments in accordance with the approved Plan of Development may have a reduced primary road setback to 3.0metres as noted on the Plan of Development Table.

Compaction of any fill material placed on this site shall be completed to level one inspection and testing services in accordance with AS3798-2007.

Location of sewer, roofwater, stormwater, water reticulation and electricity lines, manholes and pits are those shown on engineering design drawings, supplied by Peak Urban and may differ from the as-constructed location.

Plan of Development information Supplied by RPS Group PLC.

Copyright © Veris Australia Pty Ltd
December 2024

Plot Date: 11 Dec, 2024
Computer File Ref: 30109-St4H-SP-(A).dwg

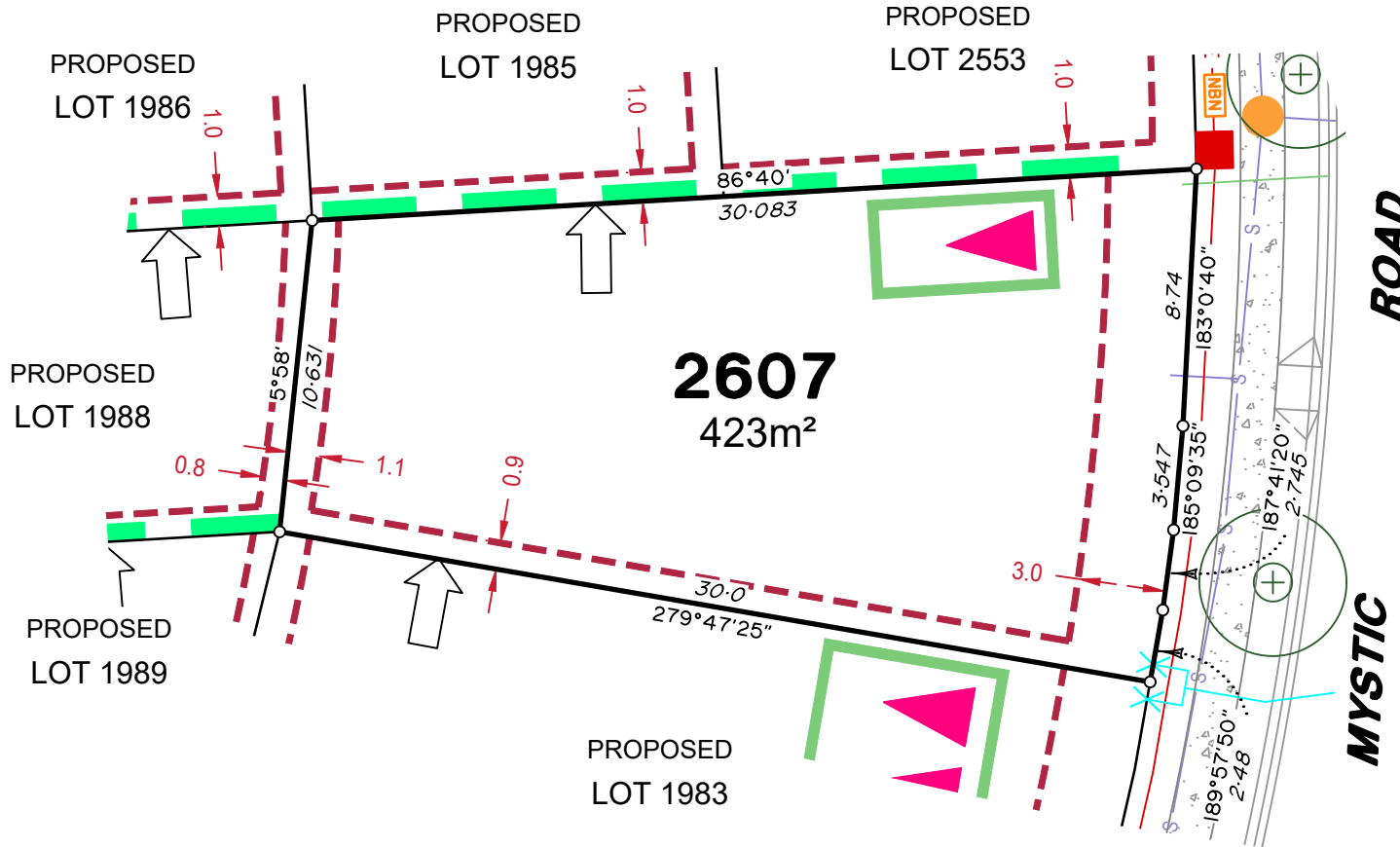

Rock Retaining Wall shown as:-	
Sleeper Retaining Wall shown as:-	
Landscape Retaining Wall shown as:-	
Sewer line	
Sewer Manhole	
Roofwater Drainage line and Catch Pit	
Stormwater Drainage Line	
Stormwater Manhole	
Stormwater Pit	
Water Main	
Water Conduit	
Water Service Point of Entry	
Underground Electricity, Street Light, Electricity Pillar & NBN	
Developer Fencing	
Concrete Pathway	
Zero Setback Building Line	
Indicative Building Envelope	
Bin Pads	
Indicative Parking Access Location	
Landscape Street Tree	

ADDITIONAL NOTES:

Allotments used as Multiple Residential Allotments in accordance with the approved Plan of Development may have a reduced primary road setback to 3.0metres as noted on the Plan of Development Table.

Compaction of any fill material placed on this site shall be completed to level one inspection and testing services in accordance with AS3798-2007.

Location of sewer, roofwater, stormwater, water reticulation and electricity lines, manholes and pits are those shown on engineering design drawings, supplied by Peak Urban and may differ from the as-constructed location.

Plan of Development information Supplied by RPS Group PLC.

Copyright © Veris Australia Pty Ltd
December 2024

Plot Date: 11 Dec, 2024
Computer File Ref: 30109-St4H-SP-(A).dwg